

ACT350/ACT350xxPOWERCELL[®]

Transmitter



ACT350/ACT350xxPOWERCELL[®]

Transmitter

METTLER TOLEDO Service

Essential Services for Dependable Performance of Your ACT350/ACT350xxPOWERCELL[®] Transmitter

Congratulations on choosing the quality and precision of METTLER TOLEDO. Proper use of your new equipment according to this Manual and regular calibration and maintenance by our factory-trained service team ensures dependable and accurate operation, protecting your investment. Contact us about a service agreement tailored to your needs and budget. Further information is available at www.mt.com/service.

There are several important ways to ensure you maximize the performance of your investment:

1. **Register your product:** We invite you to register your product at www.mt.com/productregistration so we can contact you about enhancements, updates and important notifications concerning your product.
2. **Contact METTLER TOLEDO for service:** The value of a measurement is proportional to its accuracy – an out of specification scale can diminish quality, reduce profits and increase liability. Timely service from METTLER TOLEDO will ensure accuracy and optimize uptime and equipment life.
 - a. **Installation, Configuration, Integration and Training:** Our service representatives are factory-trained, weighing equipment experts. We make certain that your weighing equipment is ready for production in a cost effective and timely fashion and that personnel are trained for success.
 - b. **Initial Calibration Documentation:** The installation environment and application requirements are unique for every industrial scale so performance must be tested and certified. Our calibration services and certificates document accuracy to ensure production quality and provide a quality system record of performance.
 - c. **Periodic Calibration Maintenance:** A Calibration Service Agreement provides on-going confidence in your weighing process and documentation of compliance with requirements. We offer a variety of service plans that are scheduled to meet your needs and designed to fit your budget.
 - d. **GWP[®] Verification:** A risk-based approach for managing weighing equipment allows for control and improvement of the entire measuring process, which ensures reproducible product quality and minimizes process costs. GWP (Good Weighing Practice), the science-based standard for efficient life-cycle management of weighing equipment, gives clear answers about how to specify, calibrate and ensure accuracy of weighing equipment, independent of make or brand.

© METTLER TOLEDO 2020

No part of this manual may be reproduced or transmitted in any form or by any means, electronic or mechanical, including photocopying and recording, for any purpose without the express written permission of METTLER TOLEDO.

U.S. Government Restricted Rights: This documentation is furnished with Restricted Rights.

Copyright 2020 METTLER TOLEDO. This documentation contains proprietary information of METTLER TOLEDO. It may not be copied in whole or in part without the express written consent of METTLER TOLEDO.

METTLER TOLEDO reserves the right to make refinements or changes to the product or manual without notice.

COPYRIGHT

METTLER TOLEDO® is a registered trademark of Mettler-Toledo, LLC. All other brand or product names are trademarks or registered trademarks of their respective companies.

METTLER TOLEDO RESERVES THE RIGHT TO MAKE REFINEMENTS OR CHANGES WITHOUT NOTICE.

FCC Notice

This device complies with Part 15 of the FCC Rules and the Radio Interference Requirements of the Canadian Department of Communications. Operation is subject to the following conditions: (1) this device may not cause harmful interference, and (2) this device must accept any interference received, including interference that may cause undesired operation.

This equipment has been tested and found to comply with the limits for a Class A digital device, pursuant to Part 15 of FCC Rules. These limits are designed to provide reasonable protection against harmful interference when the equipment is operated in a commercial environment. This equipment generates, uses, and can radiate radio frequency energy and, if not installed and used in accordance with the instruction manual, may cause harmful interference to radio communications. Operation of this equipment in a residential area is likely to cause harmful interference in which case the user will be required to correct the interference at his or her expense.

- Declaration of Conformity is available at <http://glo.mt.com/global/en/home/search/compliance.html/compliance/>.

RoHS Compliance Statement.





- The majority of our products fall within categories 8 and 9. Those categories currently do not fall within the scope of the Directive 2002/95/EG (RoHS) of January 27, 2003. If our products are intended for use in other products which themselves fall within the scope of the RoHS Directive, compliance requirements have to be separately negotiated contractually.
- Those products which fall within categories 1-7 and 10 will be in compliance with the EU RoHS Directive from no later than July 1, 2006.
- If it is not possible for technical reasons to replace any non-RoHS-compliant substances in any of the above products as required, we plan to inform our customers in a timely manner





Statement regarding harmful substances

We do not make direct use of harmful materials such as asbestos, radioactive substances or arsenic compounds. However, we purchase components from third party suppliers, which may contain some of these substances in very small quantities.

Warnings and Cautions

- READ this manual BEFORE operating or servicing this equipment and FOLLOW these instructions carefully.
- SAVE this manual for future reference.

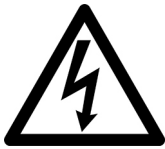
	<p style="text-align: center;"> WARNING</p>
	<p style="text-align: center;"> WARNING</p> <p>ONLY USE RECOMMENDED 12-24 VDC POWER SUPPLY APPROVED AS NEC Class 2 OR RATED AS LIMITED POWER PER IEC60950-1.</p>
	<p style="text-align: center;"> WARNING</p> <p>WHEN THIS EQUIPMENT IS INCLUDED AS A COMPONENT PART OF A SYSTEM, THE RESULTING DESIGN MUST BE REVIEWED BY QUALIFIED PERSONNEL WHO ARE FAMILIAR WITH THE CONSTRUCTION AND OPERATION OF ALL COMPONENTS IN THE SYSTEM AND THE POTENTIAL HAZARDS INVOLVED. FAILURE TO OBSERVE THIS PRECAUTION COULD RESULT IN BODILY HARM AND/OR PROPERTY DAMAGE.</p>
	<p style="text-align: center;"> WARNING</p> <p>ONLY THE COMPONENTS SPECIFIED ON THE ACT350 DOCUMENTATION MEDIA CAN BE USED IN THIS TRANSMITTER. ALL EQUIPMENT MUST BE INSTALLED IN ACCORDANCE WITH THE INSTALLATION INSTRUCTIONS DETAILED IN THE USER'S GUIDE. INCORRECT OR SUBSTITUTE COMPONENTS AND/OR DEVIATION FROM THESE INSTRUCTIONS CAN IMPAIR THE SAFETY OF THE TRANSMITTER AND COULD RESULT IN BODILY HARM AND/OR PROPERTY DAMAGE.</p>
	<p style="text-align: center;"> WARNING</p> <p>BEFORE CONNECTING/DISCONNECTING ANY INTERNAL OR EXTERNAL ELECTRONIC COMPONENTS, LOAD CELLS, HARNESSSES OR INTERCONNECTING WIRING BETWEEN ELECTRONIC EQUIPMENT ALWAYS REMOVE POWER AND WAIT AT LEAST THIRTY (30) SECONDS BEFORE ANY CONNECTIONS OR DISCONNECTIONS ARE MADE. FAILURE TO OBSERVE THESE PRECAUTIONS COULD RESULT IN BODILY HARM AND/OR PROPERTY DAMAGE.</p>
	<p style="text-align: center;"> WARNING</p> <p>INSTALLATION AND ANY SERVICE ON THIS EQUIPMENT MUST BE DONE ONLY AFTER THE AREA IS SECURED AS NON-HAZARDOUS BY THE RESPONSIBLE PERSON ON-SITE AUTHORIZED TO DO SO.</p>
	<p style="text-align: center;"> WARNING</p> <p>THE ACT350 IS NOT INTRINSICALLY SAFE! DO NOT USE IN HAZARDOUS AREAS CLASSIFIED AS DIVISION 1, ZONE 0, ZONE 20, ZONE 1 OR ZONE 21 BECAUSE OF COMBUSTIBLE OR EXPLOSIVE ATMOSPHERES.</p>

	<p style="text-align: center;">! WARNING</p> <p>DO NOT ACTIVATE POWER OVER ETHERNET (PoE) ON ETHERNET SWITCHES ON THE ACT350 NETWORK. ACTIVATING PoE MAY RESULT IN DAMAGE TO THE ACT350 TRANSMITTER.</p>
	<p style="text-align: center;">! WARNING</p> <p>IN ORDER TO ENSURE PROPER DISSIPATION OF HEAT FROM THE TRANSMITTER'S PCBs, AND TO AVOID DAMAGE TO THE EQUIPMENT, THE ACT350 MUST BE MOUNTED VERTICALLY, ON A HORIZONTAL DIN RAIL.</p>
	<p style="text-align: center;">! WARNING</p> <p>NOT ALL VERSIONS OF THE ACT350POWERCELL® ARE DESIGNED FOR USE IN HAZARDOUS (EXPLOSIVE) AREAS. REFER TO THE DATA PLATE OF THE ACT350POWERCELL® TO DETERMINE IF A SPECIFIC TRANSMITTER IS APPROVED FOR USE IN AN AREA CLASSIFIED AS HAZARDOUS BECAUSE OF COMBUSTIBLE OR EXPLOSIVE ATMOSPHERES.</p>
	<p style="text-align: center;">! WARNING</p> <p>IN ORDER TO INSTALL THE DIVISION 2 APPROVED ACT350 TRANSMITTER UTILIZING THE U.S. APPROVAL, METTLER TOLEDO CONTROL DRAWING 30315298/30369059 MUST BE FOLLOWED WITHOUT EXCEPTION. IN ORDER TO INSTALL THE CATEGORY 3 MARKED ACT350 UTILIZING THE EUROPEAN APPROVAL, THE DEKRA APPROVAL CERTIFICATE 18ATEX0036X/ IECEx DEK 18.0022X AND ALL LOCAL REGULATIONS MUST BE FOLLOWED WITHOUT EXCEPTION. FAILURE TO DO SO COULD RESULT IN BODILY HARM AND/OR PROPERTY DAMAGE. REFER TO THE ACT350 DIVISION 2 AND ZONE 2/22 INSTALLATION GUIDE 30369090/30467204 FOR ADDITIONAL INFORMATION.</p>
	<p style="text-align: center;">NOTICE</p> <p>OBSERVE PRECAUTIONS FOR HANDLING ELECTROSTATIC SENSITIVE DEVICES.</p>

Disposal of Electrical and Electronic Equipment

In conformance with the European Directive 2002/96/EC on Waste Electrical and Electronic Equipment (WEEE) this device may not be disposed of in domestic waste. This also applies to countries outside the EU, per their specific requirements.



Please dispose of this product in accordance with local regulations at the collecting point specified for electrical and electronic equipment.

If you have any questions, please contact the responsible authority or the distributor from which you purchased this device.

Should this device be passed on to other parties (for private or professional use), the content of this regulation must also be related.

Thank you for your contribution to environmental protection.

Contents

1	Introduction	1-1
1.1.	Inspection and Contents Checklist	1-1
1.2.	Model Identification	1-1
1.3.	PLC Interface Versions	1-2
1.4.	Physical Dimensions.....	1-3
2	Operation	2-1
2.1.	Front Panel	2-1
2.2.	ACT350POWERCELL® Device Main Menu	2-3
2.3.	ACT350POWERCELL® Basic Operation Functions	2-17
3	Installation	3-1
3.1.	Mechanical Installation	3-1
3.2.	Electrical Installation.....	3-2
3.3.	DIP Switches	3-9
3.4.	Legal for Trade	3-9
3.5.	Power Supply	3-10
4	Fieldbus Communication	4-1
4.1.	Overview.....	4-1
5	Troubleshooting PLC Connectivity	5-1
6	Configuration and Maintenance Tools	6-1
6.1.	ACT350/ACT350xxPOWERCELL® Webserver	6-1
6.2.	Setup+ Configuration Tool.....	6-4
7.	GEO Codes	7-1
7.1.	Original Site Calibration	7-1
7.2.	New Site GEO Code Adjustment	7-1
A	TCP/IP Communication	1
A.1.	Socket Connection	1
A.2.	Introduction to MT-SICS Commands	1
A.3.	SIX1 Command	4
A.4.	TA Command	6
A.5.	SI Command	6
A.6.	Z Command	7
A.7.	ZI Command	7

A.8.	T Command	7
A.9.	TI Command	8
A.10.	TAC Command	8
A.11.	I3 Command.....	9
A.12.	I4 Command.....	9
B	Setpoint	1
B.1.	Introduction	1
B.2.	Concurrent Mode	2
B.3.	Independent Mode	3
B.4.	Latch.....	4

1 Introduction

The ACT350 represents the latest in METTLER TOLEDO technology and is one of the most versatile weighing transmitters available today for conventional strain gauge weighing technology. The factory pre-configured PLC communication interface in a DIN rail mounting scheme makes the ACT350 a perfect match for basic industrial process weighing applications including:

- Filling
- Dosing
- Checkweighing

The ACT350POWERCELL[®] delivers fast, precise measurement data in grams, kilograms or lb in a single cost-effective package that easily integrates into control panel systems.

The versatile ACT350POWERCELL[®] excels in controlling simple filling and dosing applications, delivering best-in-class performance for fast, precise and accurate results in fully automatic operations. Utilize the control capabilities of the ACT350POWERCELL[®] to effectively manage project costs.

1.1. Inspection and Contents Checklist

Verify the contents and inspect the package immediately upon delivery.

The package should include:

- ACT350POWERCELL[®] transmitter
- Safety warnings in multiple languages
- Parts for installation including ferrite, connectors, screwdriver, etc.

NOTICE

ALL RELEVANT DOCUMENTATION, SOFTWARE, FIELDBUS FILES AND SAMPLE CODE ARE AVAILABLE AT WWW.MT.COM/IND-ACT350-DOWNLOADS

1.2. Model Identification

The ACT350POWERCELL[®] model number is located on the data plate on the side of the transmitter along with the serial number. Refer to Figure 1-1 to identify the ACT350 configuration.

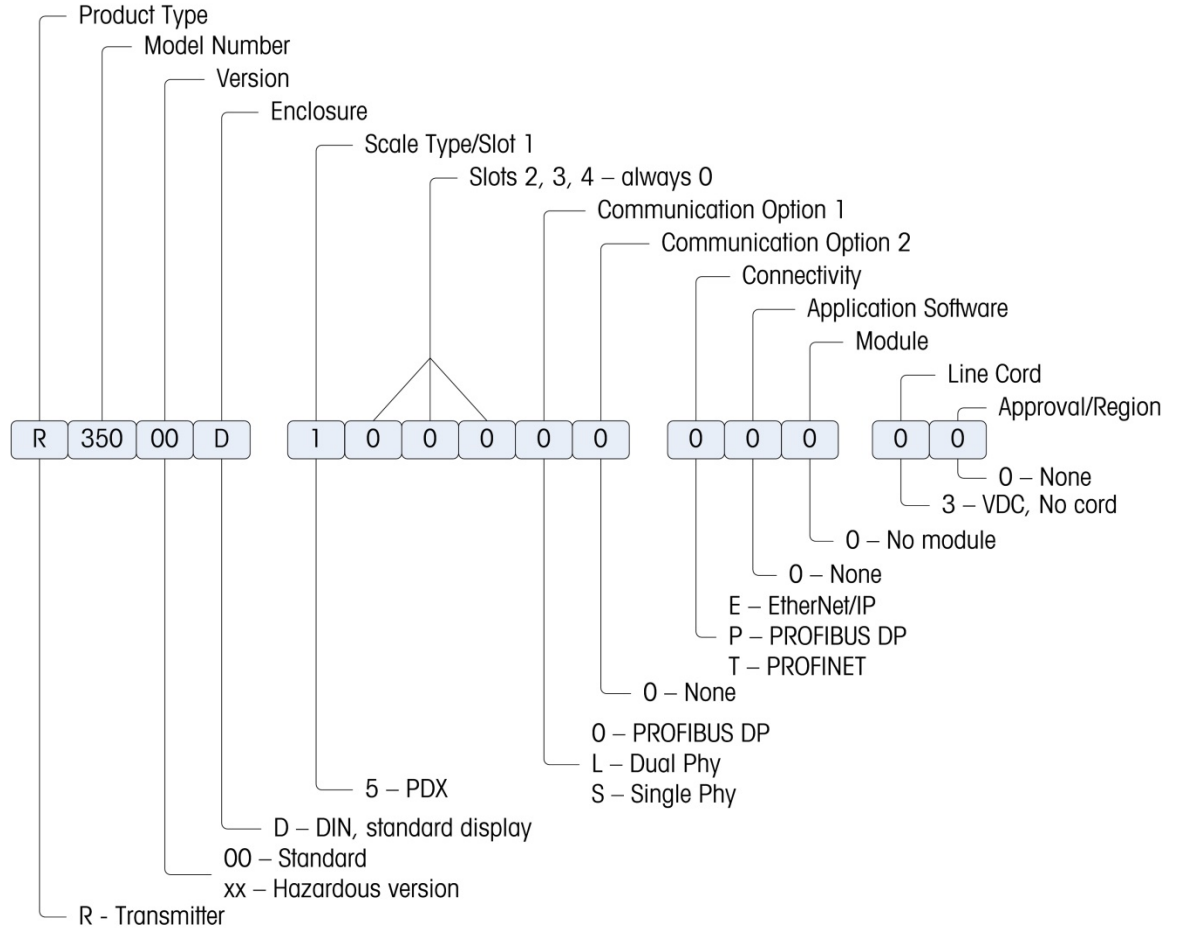

Figure 1-1 ACT350 Model Configurator

Table 1-1: ACT350 Model Configurations

Item Number	Description / SKC Number	Version	Fieldbus Type
30278660	Weight Transm. ACT350 PowerC PBDP	ACT350POWERCELL®	PROFIBUS DP
30278661	Weight Transm. ACT350 PowerC PRNT	ACT350POWERCELL®	PROFINET IO
30278662	Weight Transm. ACT350 PowerC ETIP	ACT350POWERCELL®	EtherNet/IP
30388326	Weight Transm. ACT350xx PowerC PBDP	ACT350xx POWERCELL®	PROFIBUS DP
30388327	Weight Transm. ACT350xx PowerC PRNT	ACT350xx POWERCELL®	PROFINET IO
30388328	Weight Transm. ACT350xx PowerC ETIP	ACT350xx POWERCELL®	EtherNet/IP

1.3. PLC Interface Versions

The ACT350 comes factory-configured with PLC interface options including

- PROFIBUS DP
- EtherNet/IP

- PROFINET IO

Each product version is specific to the PLC interface and cannot be changed to a different fieldbus type.

NOTICE

THIS DOCUMENT DOES NOT FOCUS ON PROGRAMMING THE USER'S PLC. DEVICE DESCRIPTION FILES, SAMPLE CODE, ENGINEERING NOTES AND SAI (STANDARD AUTOMATION INTERFACE) REFERENCE MANUAL CAN BE DOWNLOADED FROM www.mt.com/ind-act350-downloads. USE THESE TO SIMPLIFY YOUR PLC PROGRAMMING WHILE INTEGRATING ACT350.

1.4. Physical Dimensions

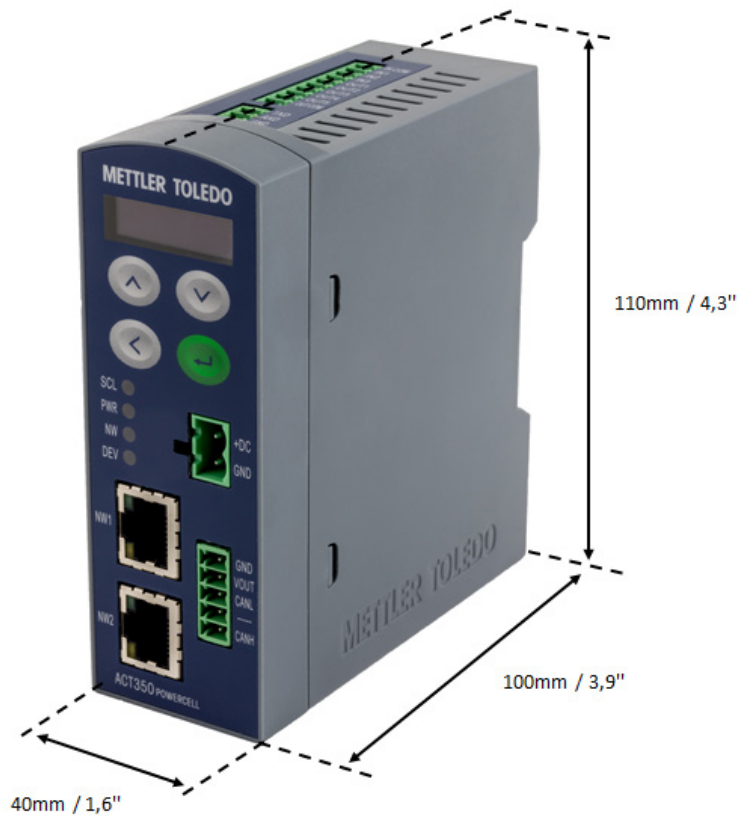

Figure 1-2: ACT350POWERCELL[®] DIN Rail-Mount Enclosure Dimensions

NOTICE

2D AND 3D DRAWINGS ARE AVAILABLE AT WWW.MT.COM/IND-ACT350-DOWNLOADS

2 Operation

2.1. Front Panel

An example of the ACT350POWERCELL[®] front panel is shown in Figure 2-1 and Figure 2-2.

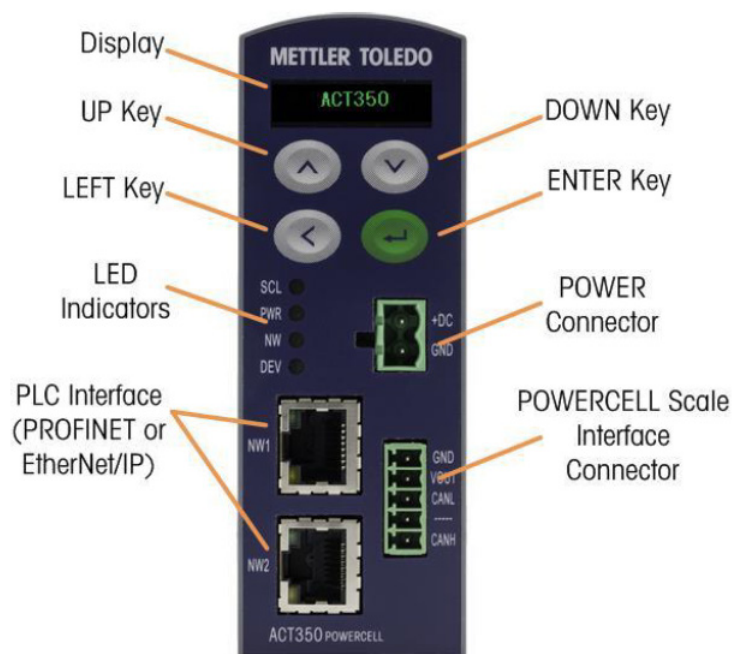

Figure 2-1: ACT350POWERCELL[®] Front Panel Layout – PROFINET or EtherNet/IP

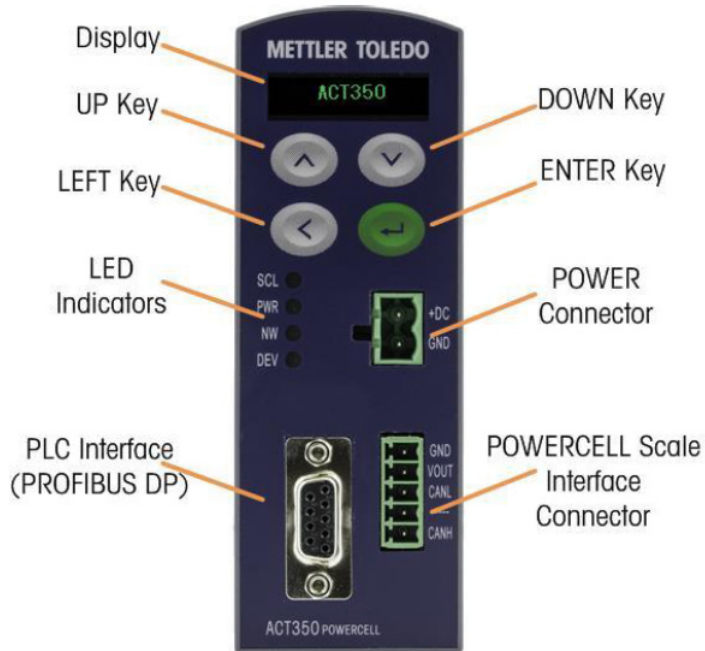

Figure 2-2: ACT350POWERCELL® Front Panel Layout – PROFIBUS DP

2.1.1. Display Layout

The ACT350 transmitter has an organic LED (OLED), 128 × 32 dot matrix graphic type display. The display is reserved for scale weight, units, Net/Gross indicator and error messages.

Additional information provided includes:

- Weight unit (lb, kg, g)
- Motion / no-motion condition
- Center of zero
- Gross or net mode



Figure 2-3: Display in Weighing Mode





<i>NOTICE</i>
THE ACT350POWERCELL WILL NOT DISPLAY WEIGHT UNTIL THE LOAD CELLS ARE ADDRESSED. SEE THE "LOAD CELL CONFIGURATION" SUBSECTION OF THIS MANUAL FOR ADDITIONAL INFORMATION
<i>NOTICE</i>
WHEN THE ACT350POWERCELL® TRANSMITTER RUNS IN RUNFLAT MODE, A CHARACTER "R" WILL APPEAR AT THE TOP-LEFT CORNER OF THE DISPLAY AND THE WHOLE DISPLAY WILL START TO BLINK

NOTICE



WHEN A POWERCELL® SIMULATOR IS CONNECTED TO AN ACT350POWERCELL® TRANSMITTER, A CHARACTER 'T' WILL APPEAR AT THE TOP-LEFT CORNER OF THE DISPLAY. THE DISPLAY WILL BLINK, INDICATING A SIMULATOR IS CONNECTED.

2.1.2. Front Panel Keys

Four dedicated function keys are located on the front panel to support manual setup configuration. These provide the interface to navigate the setup menu hierarchy and data entry, as well as make setup selections within data entry and drop down boxes.

	ENTER	<p>Press the ENTER key for 3 seconds to access the device menu. Press the ENTER key to make a selection within the device menu and sub-menus.</p> <p>When in a data entry field, press the ENTER key to accept the numeric value entered.</p> <p>When the display is in weighing mode, briefly press the ENTER key to execute the zero operation if the scale weight is within the Pushbutton zero range specified in Setup+ or the webserver.</p>
	UP	Press the UP key to scroll within the device menu and sub-menus. The UP key is also used for incrementing numerals in the numeric data entry field.
	DOWN	Press the DOWN key to scroll within the device menu and sub-menus. The DOWN key is also used for decrementing numerals in the numeric data entry field.
	LEFT	Press the LEFT key to navigate back one step on the device menu tree. The LEFT key is also used to scroll to the left by one numeral in a data entry field. With the left most numeric character highlighted, the next key press will wrap around to the right most numeral.

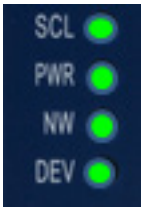
2.1.3. LED Status Indications

Normal Work	Network Error (Example)	LED	STATUS
		SCL	Scale status: ON okay, flashing indicates scale error
		PWR	Power status: ON okay, OFF error
		NW	While cyclic communication is successful, the LED will remain solid. Otherwise the LED will blink.
		DEV	Device Status: ON okay; flashing contact service

2.2. ACT350POWERCELL® Device Main Menu



From the front panel, press and hold the ENTER key for 3 seconds to access the device menu. The display will change from showing the normal weight display to showing the Information Recall  icon. Press the UP  or DOWN  keys on the front panel to display icons for the various functions listed in Table 2-1.

Table 2-1: Device Menu Icons

	Information Recall	Recall mode for most transmitter information fields.
	Resolution	Temporarily expands weight display resolution for diagnostic purposes
	Comparators	Access to the limit value for all currently enabled comparators.
	Calibration	Access to calibration menu including zero and span adjustment (in non-approved mode only).
	Error Message	Access to list of current error messages
	Language	Selects between English and Chinese
	Setup	Access to all setup parameters for the transmitter.

Once focus is in a value field, repeated presses of the UP, DOWN or LEFT keys will cycle back to the beginning, so if the LEFT key is pressed when focus is in the left-most position, focus returns to the right-most position. In the case of the UP and DOWN keys, the numerical value will cycle through numerical values and the decimal point as follows:

- 0 > 1 > 2 > 3 > 4 > 5 > 6 > 7 > 8 > 9 > - > . > 0 > 1 > ...
- 0 > . > - > 9 > 8 > 7 > 6 > 5 > 4 > 3 > 2 > 1 > 0 > . > ...

After accepting the value by pressing ENTER and the focus has moved to the parameter description, press the LEFT key to exit to the next higher level of the menu.

Pressing the LEFT multiple times will exit the device menu.

Figure 2-4 shows an example of how to access and modify the value of a parameter. The currently selected item (in focus) is indicated by reverse video.

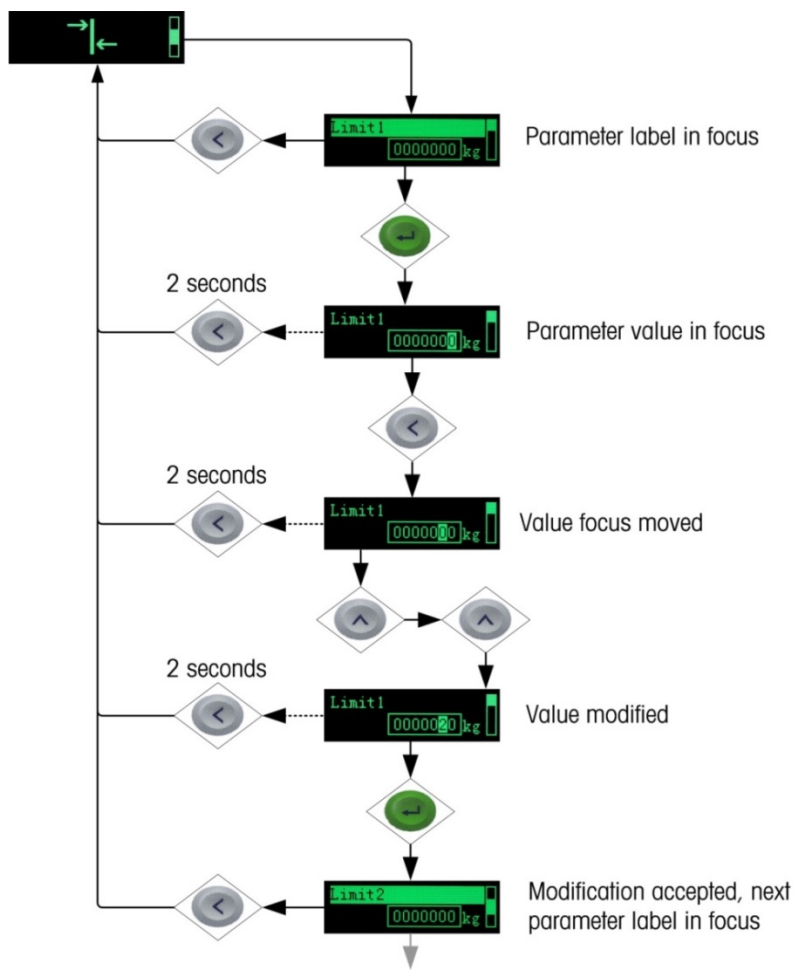

Figure 2-4: Numerical Data Entry Example

2.2.1. Information Recall



Once the Information Recall icon  appears, press the ENTER key to recall specific information about the transmitter. Press the UP  or DOWN  keys on the front panel to display transmitter information.

Table 2-2: Information Recall Menu

Model	Model of the transmitter ACT350/ACT350xxPOWERCELL
Serial Number	Serial number of the transmitter
S/W Version	Firmware version of the transmitter
PLC	PLC interface type and communication software version

Device Name (PROFINET)	Device name of the transmitter as it would appear on the network
Node Address (PROFIBUS DP)	Node address of the transmitter on the network
IP Address	IP address of the transmitter
MAC Address	MAC address of the transmitter
LC S/W Version	Software version of each load cell
Download Link	URL to the ACT350 download page

2.2.2. x10 Resolution

This function expands the weight display resolution by a factor of 10 so that a finer weight increment can be seen. It can be enabled by pressing the ENTER key  when the transmitter's device menu has been accessed and the **x10** icon is displayed on screen:



Figure 2-5: x10 Indication



NOTICE

THE x10 DISPLAY RESOLUTION SETTING CANNOT BE CONFIGURED USING SETUP+ OR THE WEBSERVER. THE FUNCTION IS INTENDED FOR DIAGNOSTIC PURPOSES ONLY. THE TRANSMITTER SHOULD NOT BE USED IN THE X10 EXPANDED MODE FOR NORMAL OPERATION. THE DATA OK BIT IS SET TO ZERO WHEN IN X10 DISPLAY MODE TO INDICATE THAT THE ACT350 IS NOT IN NORMAL OPERATING MODE. THE PLC SHOULD CONTINUOUSLY MONITOR THE DATA OK BIT FROM THE ACT350 TO DETERMINE THE VALIDITY OF DATA RECEIVED BY THE PLC.

2.2.3. Comparators

The device supports a total of five comparators. One, two or all five comparators may be used. The limit of each comparator may be modified by accessing the Comparator menu in the setup menu. Comparator values are limited to 7 digits, and can be written to the device or read from it by the PLC.

2.2.3.1. Setting Comparators

Access the Comparator menu by pressing the ENTER key  when the transmitter's device menu is visible and the |← icon is displayed on the device.

The ACT350 only supports a logical comparison of ">=", greater than or equal to, for each comparator. For example, if the limit is set to "24.00"kg, the output configured to use this comparator will be set to true only if the live weight is greater than or equal to 24.00 kg. Please note that inputs and outputs can be configured using Setup+ or the webserver.

The operator of range and other comparisons are NOT supported by the ACT350.

To edit parameters other than limits, Comparator configuration must be accessed in setup. Refer to the Numerical Data Entry section for the method used to modify numerical values.

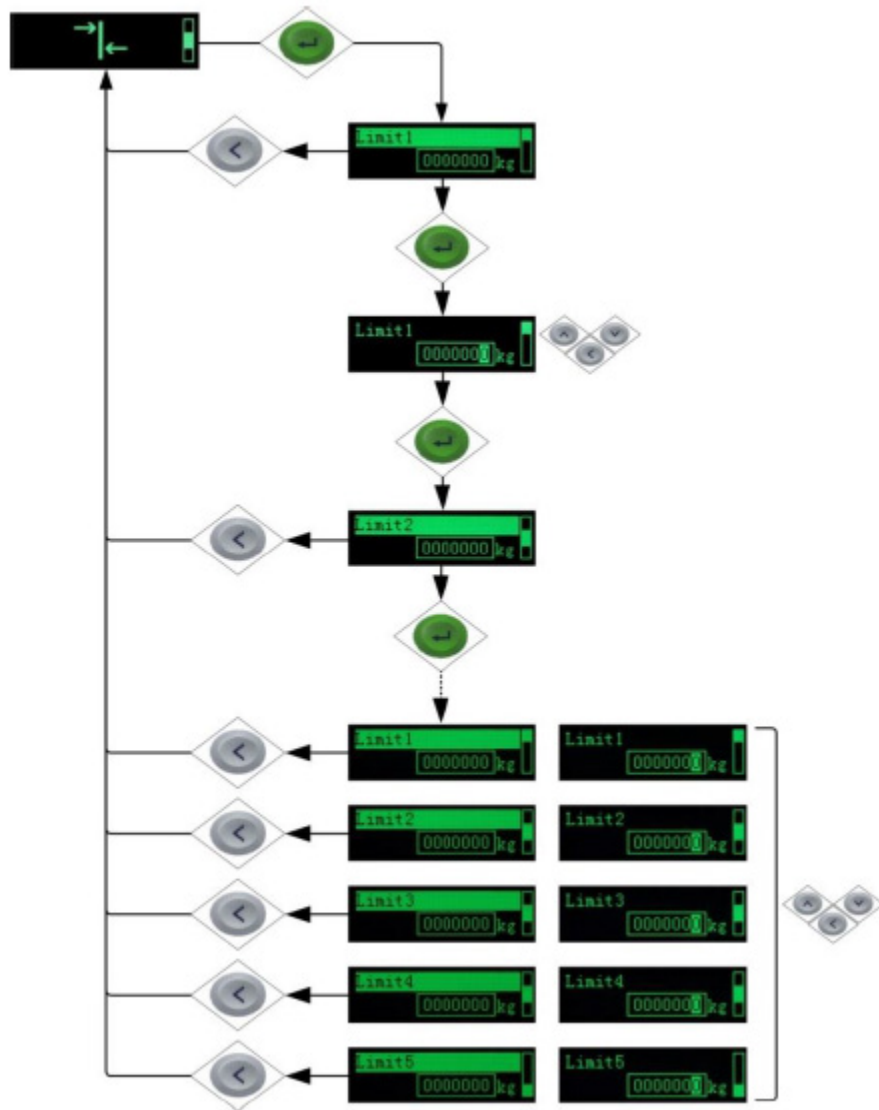

Figure 2-6: Setting Comparator Values (Limits)

NOTICE

**ONLY ABSOLUTE NUMBERS ARE PERMITTED WHEN SETTING COMPARATORS.
COMPARATOR OUTPUTS ARE NOT LATCHED AND ARE NOT SUITABLE FOR DIRECTLY CONTROLLING MATERIAL FEED DEVICES**

2.2.4. Calibration

Calibration is the process of adjusting the display of the transmitter so that when the scale is empty, the display shows zero gross weight and with a specific amount of weight on the scale, it also shows an accurate weight value.

The ACT350POWERCELL® transmitter calibration menu enables entry of a GEO Code adjustment value, selection of linearity adjustment (**none** [default], three, four or five point), traditional zero calibration and three different types of span calibration:



- **Traditional span calibration** – This uses test weights.
- **Step adjust calibration** - Using a build-up or substitution method of calibration, this method is used for large vessels where only a portion of the required test weights can be placed on the scale.
- **CalFreePlus calibration** – The transmitter will automatically calculate the span; no test weights are required.

NOTICE

PRIOR TO CALIBRATION, POWERCELLS MUST BE ADDRESSED, IF THIS HAS NOT ALREADY BEEN PERFORMED. SEE "LOAD CELL CONFIGURATION" SUBSECTION OF THIS MANUAL FOR ADDITIONAL INFORMATION.

2.2.4.1.

Setting Calibration

Access to the Calibration menu using the device's front panel is accomplished by pressing the ENTER key  when the  icon is displayed on the device. The Calibration menu also can be accessed using the PC-based Setup+ Configuration Tool or the built-in webserver.

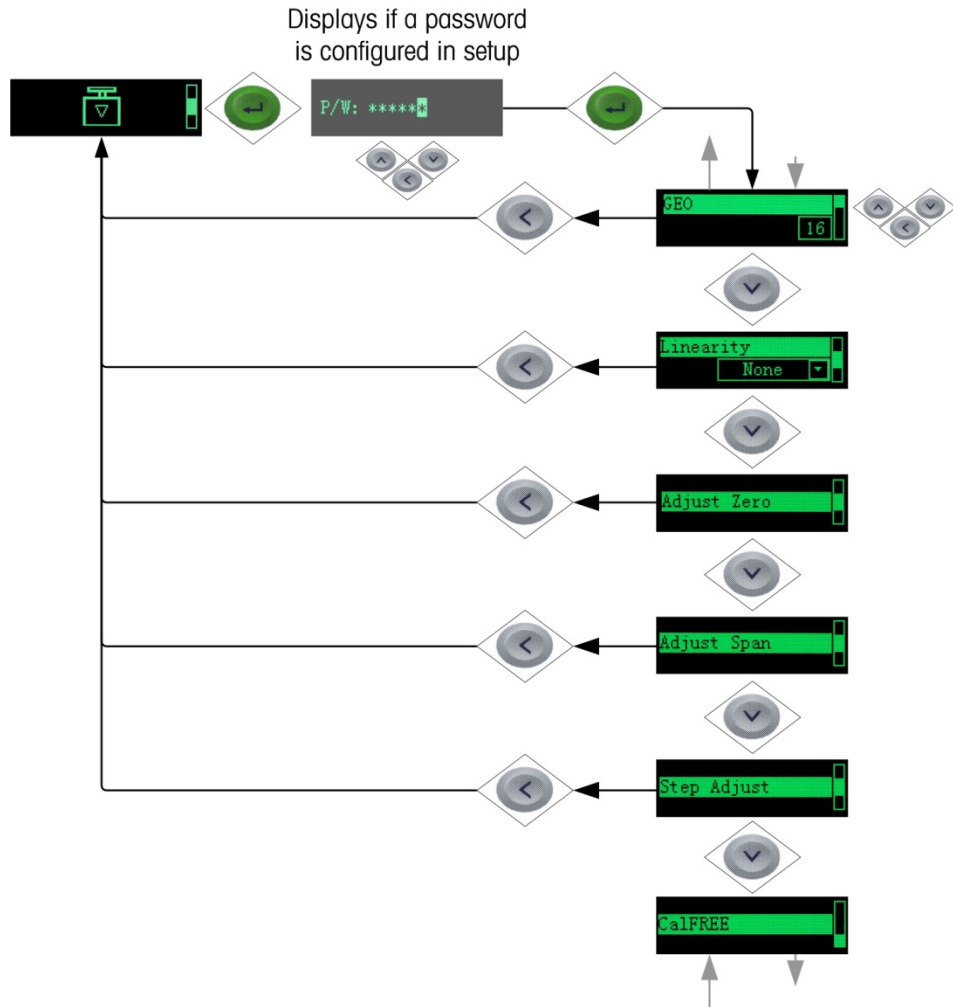

Figure 2-7: Calibration Menu – Overview

2.2.4.2. Setting Geo Code

The Geo code, which sets the appropriate adjustment value for the current geographical location, is selected here. Geo codes are numbered 0–31. Refer to section 2.2 for more information on the Geo code setting using the transmitter’s front panel buttons, and refer to Chapter 7, **Geo Codes** to find the appropriate Geo Code for the installation location.

2.2.4.3. Setting Linearity

To set the Linearity Adjustment value, see Figure 2-7. Choose the number of linearity points from the selection box. Options are **None** [default], 3 point, 4 point, 5 point.

Points are distributed as follows:

None	Linearity is disabled
3	Zero, midpoint and highpoint
4	Zero, lowpoint, midpoint and highpoint
5	Zero, lowpoint, midpoint, mid-highpoint, highpoint

2.2.4.4. Zero Calibration and Under Zero Blanking

Scale zero is set simply by emptying the scale and running the "Adjust Zero" calibration routine, as shown in Figure 2-8.

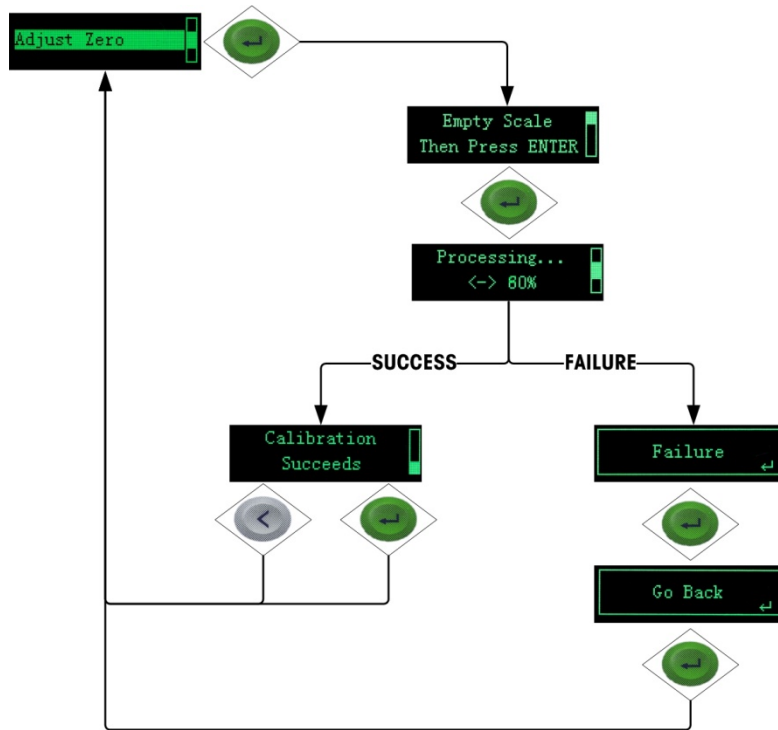

Figure 2-8: Zero Calibration

If the transmitter detects scale motion during the calibration process, it will restart the calibration process several times and then proceed, displaying a motion indication. In this case, when calibration is complete, the transmitter will present two options – accept or reject the value.

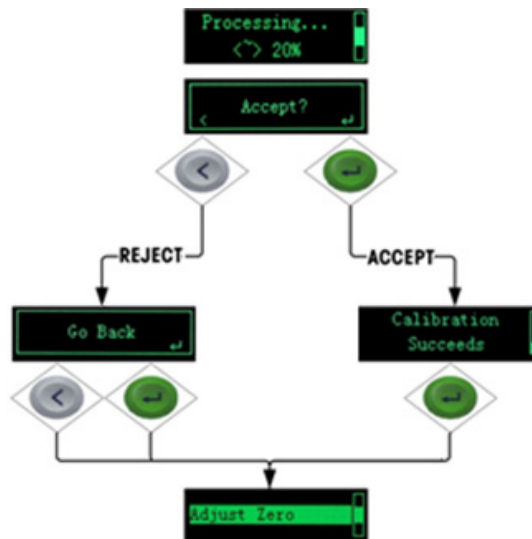

Figure 2-9: Zero Calibration with Motion

Blanking of the display is used to indicate an under-zero condition when the weight on the scale falls below the current zero reference. Set the under zero blanking for the number of divisions (d) that the transmitter is permitted to go under zero before blanking.

NOTICE

A SETTING VALUE OF 0-98 BLANKS THE DISPLAY AT THE SPECIFIED NUMBER OF DIVISIONS BELOW GROSS ZERO. A VALUE OF 99 DISABLES BLANKING UNDER ZERO AND THE TRANSMITTER WILL DISPLAY A WEIGHT UP TO 50% OF THE CAPACITY IN THE NEGATIVE DIRECTION. FOR EXAMPLE, IF THE CAPACITY IS 100KG, BLANKING WILL OCCUR AT ANY VALUE BELOW -50KG.

2.2.4.5. Span Calibration

The scale's span calibration can be determined either with or without a linearity adjustment. With linearity disabled, a single reference point is used to calibrate the scale. This is the normal method of span calibration. In Figure 2-10, the transmitter is configured with three-point linearity – low, mid and high.

The low point is set during zero calibration, and the mid and high points are set during this procedure.

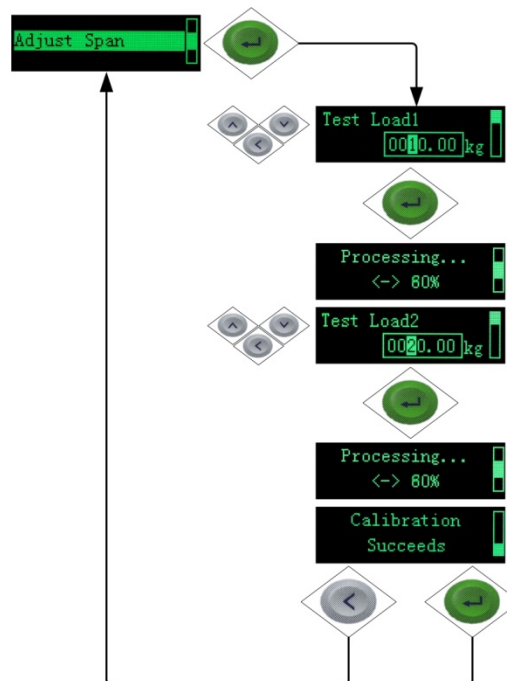

Figure 2-10: Span Calibration

If linearity is enabled, additional mid-range weight reference points are added to the adjustment procedure. Linearity can be enabled or disabled in the Calibration branch of the device menu. Refer to ACT350 Device Main Menu section for the method used to modify numerical values.

2.2.4.6. Step Adjust

Step adjustment is an iterative process in which a build-up or material substitution method of calibration is used to calibrate the span. Each step calibrates a portion of the full span.

This method is typically used with large vessels where only a portion of the required calibration test weights can be placed on the scale at one time. Figure 2-11 shows the logic of the procedure using a simple, two-step example. When sufficient steps have been calibrated, pressing the LEFT button returns the view to the calibration menu.

Step adjustment is an iterative process in which a build-up or material substitution method of calibration is used to calibrate the span. Each step calibrates a portion of the full span.

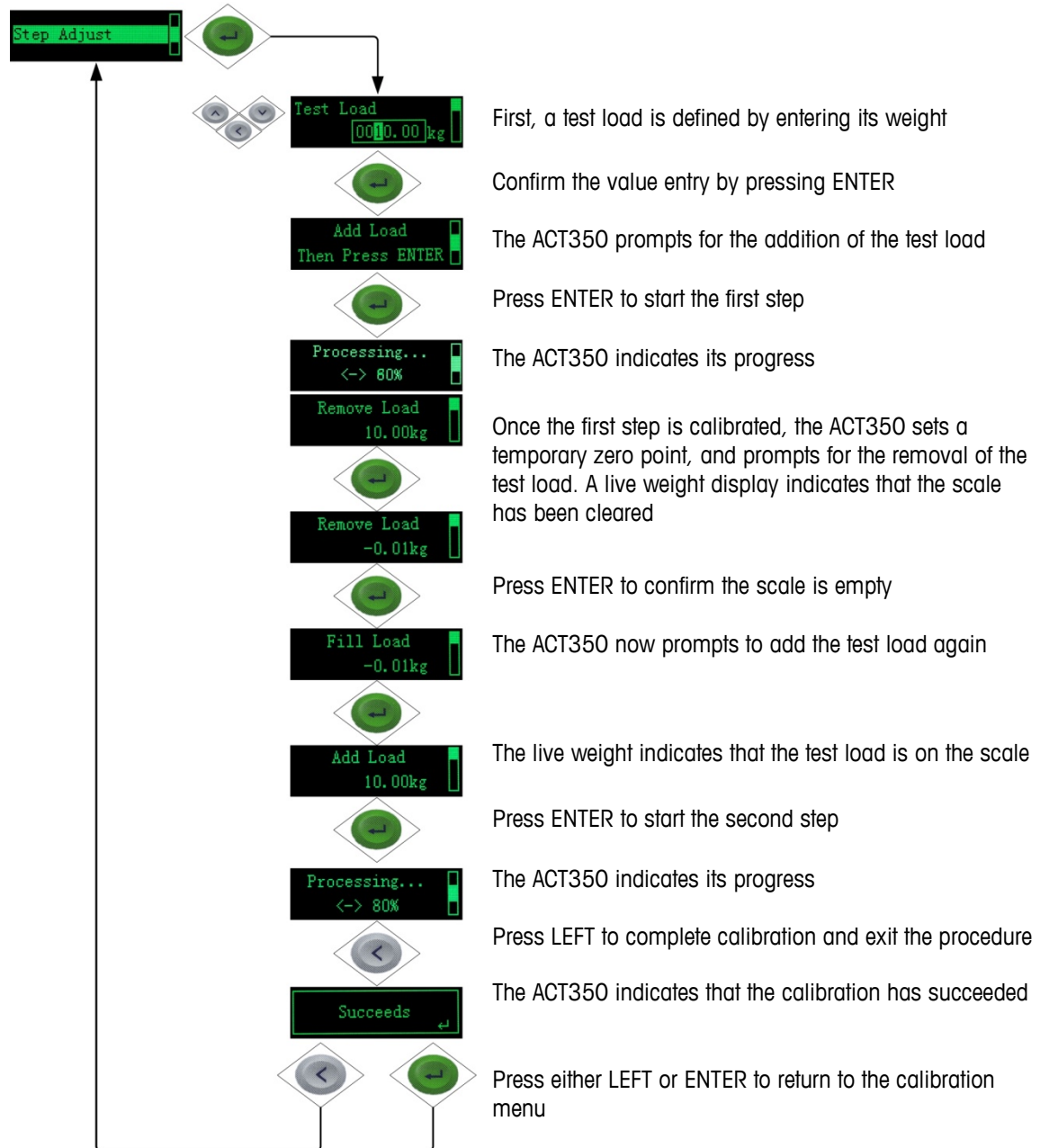

Figure 2-11: Step Adjustment

2.2.4.7. CalFreePLUS™

The ACT350POWERCELL® transmitter provides a method to calibrate a scale without using test weights. This method of calibration can be used for initial check-out and testing of systems or when a large structure is used as the weighing vessel and it is not possible to apply test weights to the structure. To execute the CalFreePLUS calibration, the user does not need to enter any parameters. Select "CalFreePLUS --> Perform CalFree" and the calibration will be done automatically. METTLER TOLEDO strongly recommends that test weights be used whenever possible as this provides the most accurate method of calibration.

2.2.5. Language

The ACT350POWERCELL® supports a device menu in **English** [default] and in Chinese.

2.2.6. Setup Access

The last icon displayed in the device menu from the front panel is Setup , where many of the transmitter's programming parameters can be viewed and modified. It is not intended that operators enter the setup mode after a weighing system is installed and is operational. It should not be necessary for an operator to access setup.

2.2.6.1. Capacity & Increment

Unit	Select the units for the scale from grams (g), kilograms (kg) or pounds (lb)
Capacity	Select the maximum capacity for the scale. Always confirm the increment size after changing the capacity since one setting may affect the possible options for the other.
Increment	Select the increment size for the scale from a drop down list. Only possible options based on your currently selected capacity will be available here. If the increment size you need is not available, you may need to decrease your capacity.

2.2.6.2. PLC Settings

The PLC menu of the ACT350POWERCELL® allows the user to change settings related to how the transmitter communicates to the PLC. These settings can also be changed in Setup+ or the webserver. See the Fieldbus Communication section of this manual for more information on the Standard Automation Interface (SAI).

Assignment	SAI: The ACT350POWERCELL® always uses the Standard Automation Interface (SAI)
Format	1 Block Format: Provides both cyclic floating point data (typically weight) along with basic status information to the PLC 2 Block Format: Provides all of the information from the one block format plus an additional block of more detailed status information.
Byte Order	Automatic, Big Endian or Little Endian: Recommended to use the default automatic setting unless communication issues occur. This will automatically determine the proper byte order needed based on your communication protocol

**PROFIBUS/
PROFINET/
EtherNet/IP**

MAC Address: Displays the MAC address, which cannot be edited.

DHCP: Dynamic Host Configuration Protocol (DHCP) can either be **enabled** or **disabled**. This setting is disabled by default.

IP Address: Default value is **192.168.000.002**. Each device on your network must have a unique IP address. So if using multiple ACT350s, the IP address of all but one must be changed. See the PC Setup section of this document for more information.

Subnet Mask: Default value is **255.255.255.000**. There is typically no need to change this value. See the PC Setup section of this document for more information.

Gateway: Default value is **000.000.000.000**. There is typically no need to change this value.

2.2.6.3. Serial Settings

Change these settings to match the serial settings of your PC in order to establish communication with the Setup+ program.

- Baudrate** Select serial communication speed of **300, 600, 1200, 2400, 4800, 9600, 19200, 38400, 57600** or **115200** bits per second.
- Data Bit** Select either **7** or **8**
- Parity** Select either **None, Even** or **Odd**
- Serial Test** Perform a serial test. The ACT350POWERCELL® will transmit a number once per second. The transmitted number will start at 0 and increment by one each second. The ACT350POWERCELL® will also display serial messages it receives during the test.

2.2.6.4. POWERCELL® Configuration

Your POWERCELL® system must be properly configured before first use with the settings below:

- # of active LCs** **1-14:** Enter the number of actual POWERCELL® load cells being used in the scale
- # of dummy LCs** **0-14:** Commonly used in level detection systems. Enter the number of support points for the scale that are not actively measuring the weight.
- Shift Adjust by** **Cell:** Adds a factor to each load cell output to compensate for the slight differences between them. The scale will then output the same weight value regardless of the physical location of the weight on the scale.
Pair: Ensures a constant reading from the scale regardless of where the load is placed on the long axis between pairs of cells

2.2.6.5. Load Cell Configuration

This menu enables the user to address load cells. Prior to calibration, every POWERCELL® load cell must be addressed.

Multiple Address	Typically, this is used when installing a new scale with load cells that have the factory default node address. Connect all load cells to the ACT350POWERCELL [®] and begin automatic configuration. After some time, each load cell will be given a node number automatically. The node numbers are allocated based on the order of the last 4 digits of the load cell serial number. Once automatically assigned, the user can manually change the node number of any load cell before confirming. Once confirmed, the device will finish addressing each load cell.
Single Address	Typically would be used during the replacement of a cell, off-site testing or pre-installation when there is only one cell connected in the network. If multiple cells are connected, the device will only display the serial number and node of the first load cell discovered. When replacing a single load cell: Connect only the unaddressed load cell to the ACT350POWERCELL [®] , begin single address configuration, set the node number to the node being replaced or added (confirm the serial number for the load cell is correct), and then connect all load cells for standard operation.
Shift Adjust	Small mismatches in mechanical and electronic gain of the load sensing paths can cause the same test weight to produce slightly different readings, depending on the location of the test weight on the scale. This procedure adds a factor to compensate for that. Will shift adjust by cell or pair based on setting used in POWERCELL [®] configuration menu.
Shift Adj Single	This procedure allows the user to quickly adjust the shift values for a single pair or single cell after a cell has been replaced on the scale. A complete shift adjust is more accurate and should be used if more than one POWERCELL [®] load cell has been replaced on the scale.

2.2.6.6. RunFlat

If the ACT350POWERCELL[®] determines that a load cell is operating out of tolerance or fails to detect communication with a single load cell, it can invoke the RunFlat algorithm to compensate for the cell's questionable readings until the cell can be replaced. This algorithm is intended for processes with a constant center of gravity.

RunFlat Config	Automatic or Off: Configure RunFlat to either be off and never turn on or to automatically trigger as soon as communication issues are detected with a load cell. The transmitter will automatically exit RunFlat mode once the communication issues are no longer present.
Temperature Trig	Disabled or Enabled: Use to trigger RunFlat if a load cell is found to be operating outside of its recommended temperature range.
Clr Ovd Sts	Clear the overload status. Once the overload status has been triggered, it is not automatically reset until the measured weight falls below 90% of the overload threshold value. This option allows the user to manually reset the overload status before the measured weight drops below 90% of the overload value.

NOTICE

WHEN THE ACT350POWERCELL[®] TRANSMITTER OPERATES IN RUNFLAT MODE, A CHARACTER "R" WILL APPEAR AT THE TOP-LEFT CORNER OF DISPLAY AND THE WHOLE DISPLAY WILL START TO BLINK.

2.2.7. Password Security

Note that a security password can be enabled in setup from the PC-based Setup+ Configuration Tool or the built-in webserver. When a password is set, it must be entered to access setup. This protects the setup parameters from inadvertent changes. The default password is "000000". Please note that if the password is lost, only a master reset can revert the password to the default value.



Figure 2-12: Password Entry Screen

2.2.8. Reset Configuration and Master Reset

2.2.8.1. Reset Configuration

To reset all configured items except calibration data:

1. Remove power from the transmitter.
2. Locate the DIP switches, accessible from the underside of the housing.
3. Set both DIP switches, 1 and 2, to ON (up, in Figure 2-13), and restore power to the transmitter.

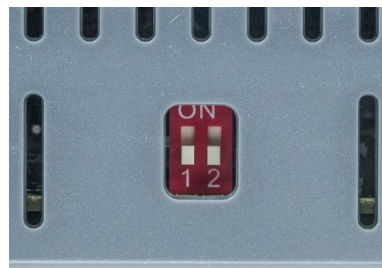

Figure 2-13: DIP Switches

4. Set both DIP switches to OFF.

2.2.8.2. Master Reset

A master reset restores all settings to their factory default values:

1. Remove power from the transmitter.
2. Set switch 2 to its ON position and restore power to the transmitter. The ACT350 will prompt for confirmation.

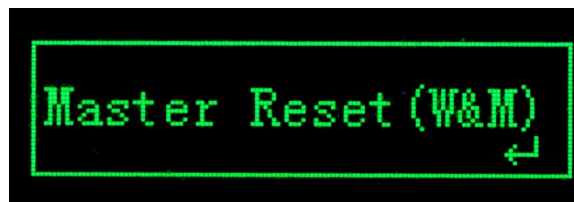

Figure 2-14: Master Reset Confirmation

3. Press ENTER on the front panel to perform the master reset.
4. Set Switch 2 to OFF.

2.3. ACT350POWERCELL[®] Basic Operation Functions

2.3.1. TCP/IP Communication

Software version V2.01.0012 or later enables the ACT350 to “talk” with a PC or HMI via TCP/IP communication. The PC or HMI can connect to ACT350POWERCELL[®] to read weight and status data and perform remote Zero/Tare/Clear operations over the Ethernet connection. This communication functionality is only available for PROFINET or EtherNet/IP versions of ACT350POWERCELL[®].

Refer to Appendix A for details.

2.3.2. Fast Replacement via LLDP(Link Layer Discovery Protocol)

The LLDP feature is only available for PROFINET versions of ACT350POWERCELL[®]. This makes it very easy to replace an old or faulty unit with a new one. It is only necessary for the new ACT350POWERCELL[®] unit to use the same physical port on the switch that the old ACT350POWERCELL[®] unit used. When powering up, the networking information will be downloaded automatically from the PLC to the new ACT350POWERCELL[®] unit.

2.3.3. Zero

The Zero function is used to set or reset the initial zero reference point of the transmitter. There are two types of zero setting modes:

2.3.3.1. Green ENTER Button

The zero function can be accomplished by a short press of the green ENTER  scale function key. The Zero range selections include Disabled, 2% [default] or 20% plus or minus from the calibrated zero point. A change to the default setting is done via the PC-based Setup+ Configuration Tool or the built-in webserver. If the current scale weight is outside the zero range when a pushbutton zero is commanded, the transmitter will display a message:

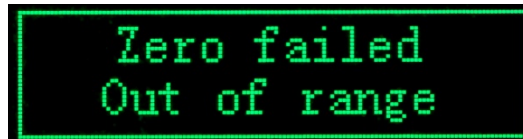

Figure 2-15: ENTER button Zero Failure Message

Remote initiation of the semi-automatic Zero command is possible via a command initiated by the PLC interface.

2.3.3.2. Power Up

The Power Up mode setting determines if at power up, the transmitter will restart with the most recent zero reference point it had before power down or if it will reset to the calibrated zero reference.

The selections include **Reset** [default] and **Restart**.

2.3.3.2.1. Reset

With the setting on **Reset**, the last zero calibration value will be used as the zero reference point. The Power Up Zero capture range selections include **Disabled** [default], 2% or 10% plus or minus. If the range setting is enabled, the Power Up Zero is applied only when the weight reading on the scale is within the selected range around the originally calibrated zero reference. For example, if the range setting for Power Up Zero is set at +/- 2%, Power Up Zero will only occur when the weight reading on the scale is within +/- 2% of scale capacity above the original calibrated zero reference. If the weight on the scale is outside of the zero range, the display will indicate **EEE** until the weight is adjusted to within this range and zero is captured.

2.3.3.2.2. Restart

A setting of **Restart** enables the transmitter to reuse the most recent zero reference weight after a power cycle so it returns to the same, previously-displayed gross weight value. The Power Up Zero setting is configured using the PC-based Setup+ Configuration Tool or the built-in webserver.

2.3.4. Tare

The tare value is subtracted from the gross weight measurement, providing the computation of the net weight (material without the container). The tare function can also be used to track the net amount of material being added to or removed from a vessel or container. In the second case, the weight of the material inside is included with the tare weight of the container and the display reflects the net amount being added to or removed from the vessel. Tare is captured by PLC command, by a configured input on an ACT350 unit or via the webserver. Tare is cleared by PLC command, by a configured input on an ACT350POWERCELL® unit or via the webserver. Inputs and outputs can be configured using Setup+ or the webserver.

2.3.5. Filter

In many weighing applications, vibration can introduce error into your system or cause delays in the transfer of weight to your automation device. It is always recommended to first attempt to mechanically isolate your scale from the surroundings.

METTLER TOLEDO POWERCELL® brand load cells contain active weighing electronics that actively adjust the weight to achieve maximum performance including filtering local to the load cell. Should this not be enough for your automated weighing application you have the choice of additional filter settings in the ACT350POWERCELL® Transmitter's low pass filter.

Low Pass Filter **Very Light, Light, Medium or Heavy:** The heavier the filtering, the slower the display settling time will be as well as the latency of the system. It is recommended to start at "Very Light" and progress upwards until your desired result is obtained.

Stability Filter **Enabled:** Should only be used for non-automatic, human-powered weighing. Gives the most stable response that is required for "legal for trade" weighing. Not recommended with a process controlled by an automation device.

Disabled: Intended setting when process is controlled by automation device such as a PLC.

2.3.6. Error Messages

With the Errors icon  in view, press the ENTER key to access a listing of current error messages.

Table 2-3: ACT350 Faults

Error	ACT350POWERCELL® Display	Description	Action
002	Remote calib.	Remote Calibration (by Setup+ or WebServer) is in process	Allow calibration to finish
005	NW Module init.fail	SAI initialization failure	Cycle power; call Service if error persists
006	NW connection disconnected	Network connection lost	Check network cable or connector
009	Board info. err	Hardware error	Cycle power; call service if issue persists
010	Calib. block err	Calibration block data lost	Perform master reset Re-calibrate
011	Scale block err	Scale block data lost	Perform master reset Access setup for scale block
012	Term. block err	Terminal block data lost	Perform master reset Access setup for terminal block
013	APP. block err	Application block data lost	Perform master reset Access setup for application block
014	COM. block err	Communication block data lost	Perform master reset Access setup for communication block
015	Maint. block err	Statistics block data lost	Perform master reset Access setup for maintenance block
018	Zero failed Motion	Scale in motion when Zero attempted	Zero when scale is stable. Replace unstable load cell/s
019	Zero failed net mode	Scale in net mode when Zero attempted	Clear tare before zeroing
020	Zero failed out of range	Weight out of Zero range	Unload scale and zero
021	Zero failed Zero disabled	Zero attempted when function disabled in setup	Enable Zero function in Setup
022	Tare failed Motion	Scale in motion when Tare attempted	Tare when scale is stable
027	Tare failed Not rounded value	Preset tare value not in display increment size	The preset tare value must be rounded to the same increment

Error	ACT350POWERCELL® Display	Description	Action
028	Tare failed Value too small	Tare value too small	The preset tare value must be minimum of 1 display increment
029	Tare failed Zero not captured	Power-up zero not captured; Zero not captured after power cycle (with Zero capture enabled) when tare was attempted	Disable zero capture at power-up or unload scale and power-up again, then tare
030	Tare Failed, Scale Over capacity	Tare was attempted while scale was over capacity	Remove weight and tare within weighing range
031	Tare failed Negative value	Tare value is less than capture or saved zero value	The preset tare value must be positive and non-zero
038	LC Supply Beyond Voltage	Overvoltage or under voltage of power supply for LCs	Check the power supply and ACT350 POWERCELL® product type whether support hazardous application
039	LC Supply Over Current	Overcurrent of power supply for LCs	Check the power supply, ACT350 POWERCELL®, LCs and confirm if all are normal
040	LC Enclosure Broken	Gas sensor value of LCs is between -5% and 10%	Replace load cell
041	LC Temperature Beyond Normal	The LC temperature is beyond normal range(-10°C~40°C)	Replace load cell
042	LC Temperature Beyond Operate	The LC temperature is beyond operate range(depend on LC type, for example -30°C~55°Cfor PDX)	Check the environment of the weighing scale and confirm if LC is normal
043	LC Communication Error	Lost communication between LCs and ACT350 POWERCELL®	Check the active LC counts and connection cables
044	LC Over Load Beyond Normal	The weight value is between 101% and 150% of normal LC capacity	Check the weighing scale
045	LC Over Load Beyond Operate	The weight value is more than 150% of normal LC capacity	The LCs could be damaged. Check the weighing scale condition.
046	LC Mixture err	LC Type Mix Different types of LCs are detected	Check the LC type. Only one type of LCs is allowed to be connected.
047	LC UnderLoad Error	The load cell weight output is negative out of normal range	Check the shift adjust parameters; Check whether the load cell is normal

Error	ACT350POWERCELL® Display	Description	Action
048	LC configure block err	POWERCELL® configuration block data lost	Perform master reset Perform setup for LC block

3 Installation

3.1. Mechanical Installation

The ACT350POWERCELL® mounts to a standard DIN rail. DIN mount includes an integral transmitter grounding system, visible in Figure 3-1.

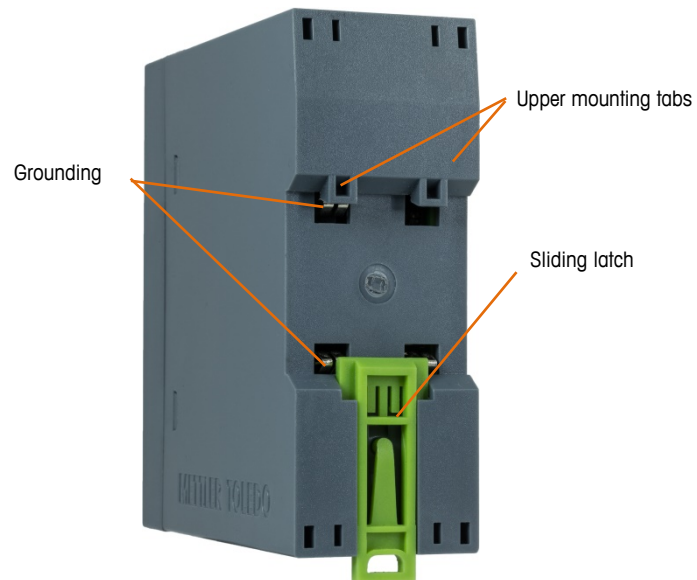

Figure 3-1: DIN-Mount Latch

To mount the ACT350POWERCELL® on a rail, open the latch by pulling down, then position the transmitter so that its upper tabs rest on the DIN rail.

Use a screwdriver to close the latch and secure the transmitter in position.

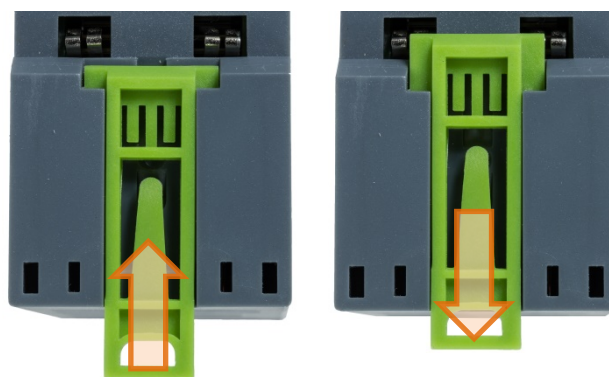

Figure 3-2: Latch Closure

To remove the ACT350POWERCELL[®], simply put the blade of a screwdriver in the latch and press it downward.

<i>NOTICE</i>
IN ORDER TO ENSURE PROPER DISSIPATION OF HEAT FROM THE TRANSMITTER'S PCBs, AND TO AVOID DAMAGE TO THE EQUIPMENT, THE ACT350POWERCELL[®] MUST BE MOUNTED VERTICALLY ON A HORIZONTAL DIN RAIL.

3.2. Electrical Installation

Figure 3-3 shows the ACT350POWERCELL[®] connections and their functions.

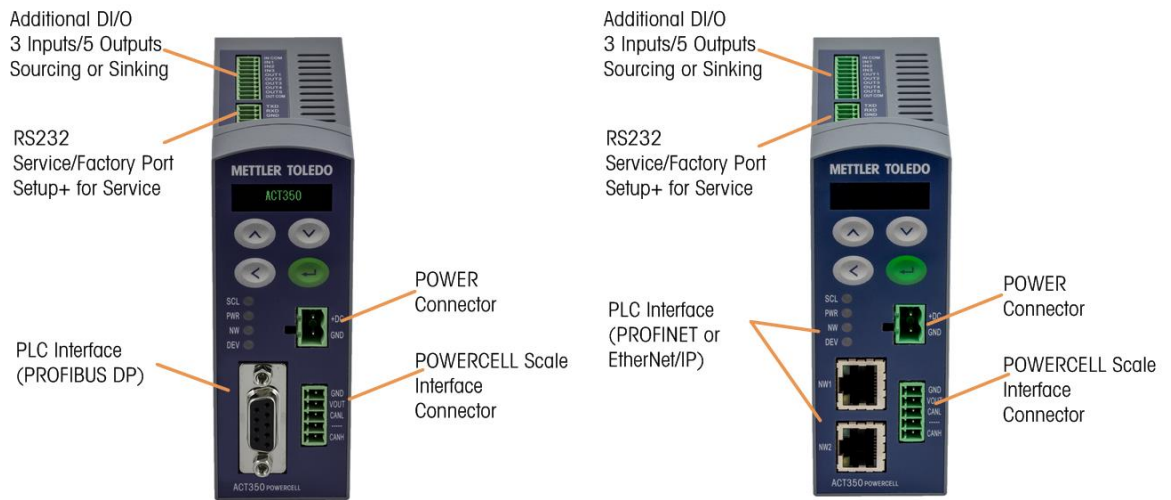



Figure 3-3: ACT350POWERCELL[®] Interfaces – PROFIBUS (left) and PROFINET or EtherNet/IP (right)

	<h3 style="margin: 0;">WARNING</h3>
	<p>IN ORDER TO INSTALL THE DIVISION 2 APPROVED ACT350 TRANSMITTER UTILIZING THE U.S. APPROVAL, METTLER TOLEDO CONTROL DRAWING 3031 5298/30369059 MUST BE FOLLOWED WITHOUT EXCEPTION. IN ORDER TO INSTALL THE CATEGORY 3 MARKED ACT350 UTILIZING THE EUROPEAN APPROVAL, THE DEKRA APPROVAL CERTIFICATE 18ATEX0036X/ IECEx DEK 18.0022X AND ALL LOCAL REGULATIONS MUST BE FOLLOWED WITHOUT EXCEPTION. FAILURE TO DO SO COULD RESULT IN BODILY HARM AND/OR PROPERTY DAMAGE. REFER TO THE ACT350 DIVISION 2 AND ZONE 2/22 INSTALLATION GUIDE 30369090/30467204 FOR ADDITIONAL INFORMATION.</p>
<h3 style="margin: 0;"><i>NOTICE</i></h3>	
<p>THE SPECIAL AUTOMATIC GROUNDING SYSTEM AT THE BACK OF THE UNIT IS PRESENT TO ENSURE THAT THE UNIT IS GROUNDED TO THE DIN RAIL. SEE FIGURE 3-1</p>	

3.2.1. RS-232 Serial Connection

The serial RS-232 connection on top of the transmitter is used for service purposes only Figure 3-4.

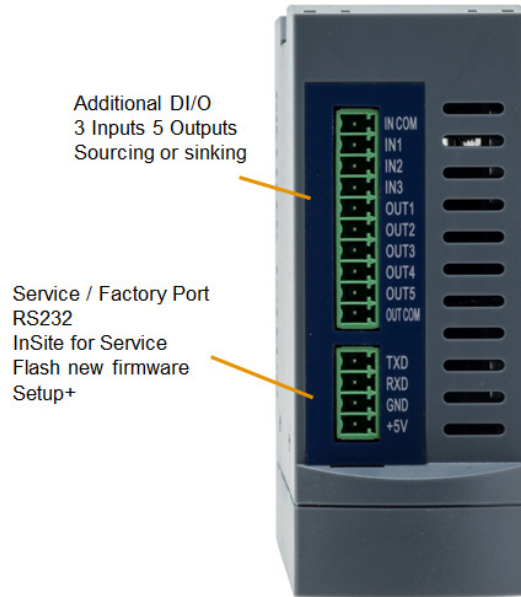

Figure 3-4: ACT350 POWERCELL, Top View

The Figure 3-5 presents the correct RS-232 wiring connection.

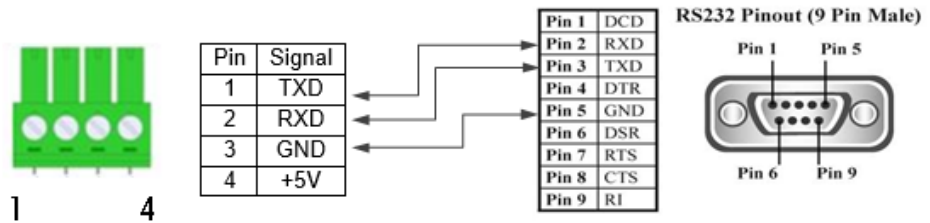

Figure 3-5: RS-232 Wiring Connection

NOTICE

DIO IS AVAILABLE IN VERSIONS WITH DUAL PORTS.

THE RS-232 PORT CAN BE USED TO CONNECT ACT350POWERCELL® TO THE PC-BASED SETUP+ CONFIGURATION TOOL.

THIS TOOL IS AVAILABLE ONLINE AND CAN BE DOWNLOADED AT WWW.MT.COM/IND-ACT350 POWERCELL-DOWNLOADS

3.2.2. Digital Inputs and Outputs Connection

Three digital inputs and five outputs are located on top of each ACT350POWERCELL[®] version Figure 3-4 and Table 3-1 show the digital input and output specifications.

Table 3-1: Digital Inputs and Outputs Specification

	Input	Output
Permissible input voltage	0 ~ 24 VDC	5~30 VDC
Logical Low-level	0 ~ 5 VDC	
Logical High-level	10 ~ 24 VDC	
Input resistance	>3K Ω	
Max.current of one output		<150mA
Accumulated current of all outputs		<750mA
Sinking Connection	GND connected to IN-COM	GND connected to OUT-COM
Sourcing Connection	Power source to IN-COM	Power source to OUT-COM
Default function	Zero	
Polarity Value	+True(Default) or -True	
Available Functionality	None; Clear Tare; Tare; Zero	None; Center of Zero; Comparator 1-5; Fault; Motion; NET; Over Capacity; Under Zero

3.2.2.1. Example

Using a rising-edge input signal to trigger the ACT350POWERCELL[®] to perform a Zero operation, "Polarity" can be set as "+ True" and "Assignment" as "Zero". Refer to Figure 3-6:



Figure 3-6: A Rising-edge Trigger Signal on Input

Using a falling-edge signal on the input to trigger ACT350POWERCELL[®] to perform a Tare operation, "Polarity" can be set as "- True" and "Assignment" as "Tare". Refer to Figure 3-7.

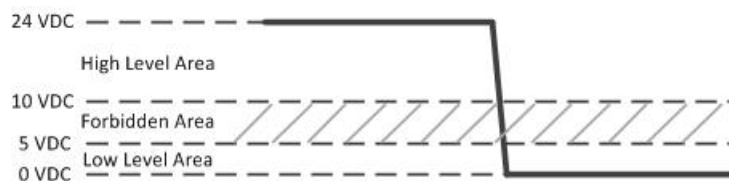

Figure 3-7: A Falling-edge Trigger Signal on Input

NOTICE

DO NOT USE INPUT VOLTAGE BETWEEN 5 – 10 VDC. UNSTABLE INPUT OPERATION WILL RESULT. SEE FIGURES 3-6 AND 3-7 FOR PROPER OPERATION.

ACT350POWERCELL® supports both Sinking and Sourcing wiring on DIO Input and Output. Please refer to Figure 3-8 to Figure 3-11.

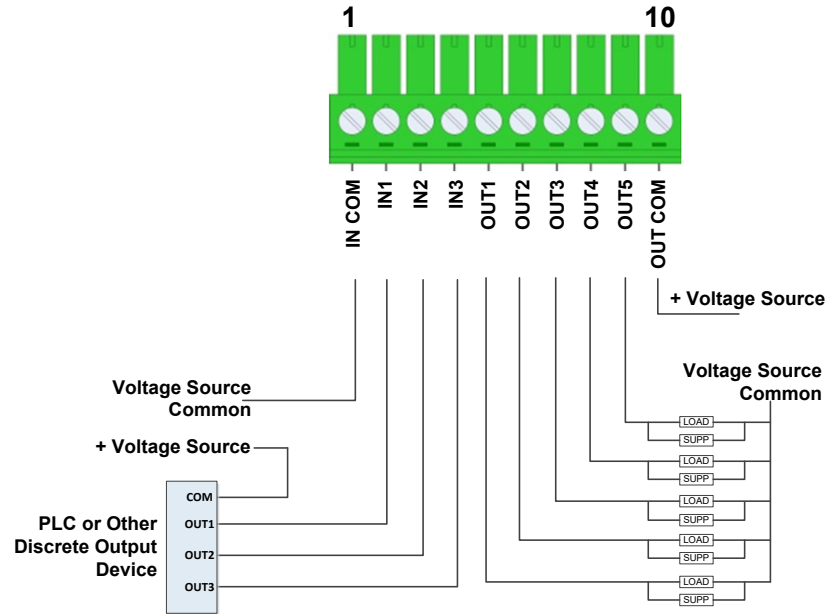

Figure 3-8: Sinking Input, Sourcing Output

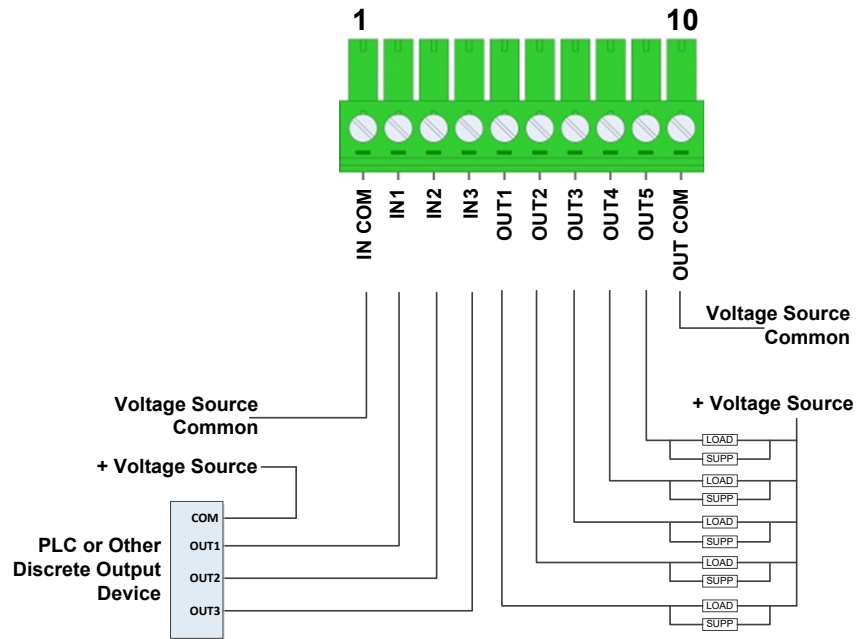

Figure 3-9: Sinking Input, Sinking Output

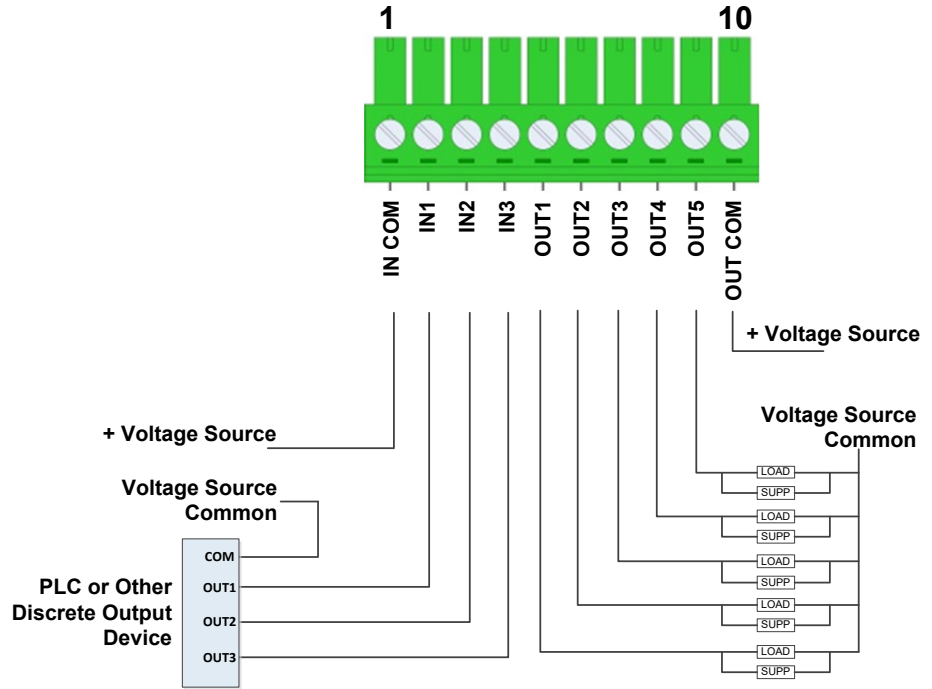

Figure 3-10: Sourcing Input, Sourcing Output

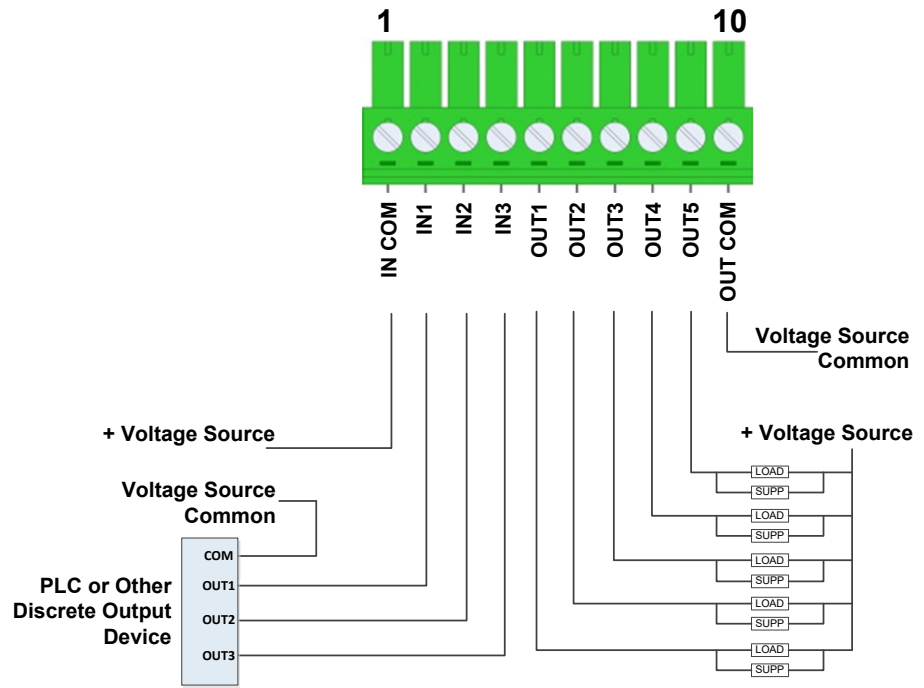

Figure 3-11: Sourcing Input, Sinking Output

3.2.3. POWERCELL® Load Cell Connection

For EMC protection, cabling for the POWERCELL® load cell must include a ferrite, included with the transmitter.

Install the ferrite by passing it through the ferrite and wrapping it around as indicated in Figure 3-12. It is recommended to strip the outer shielding of the wires about 31 cm.

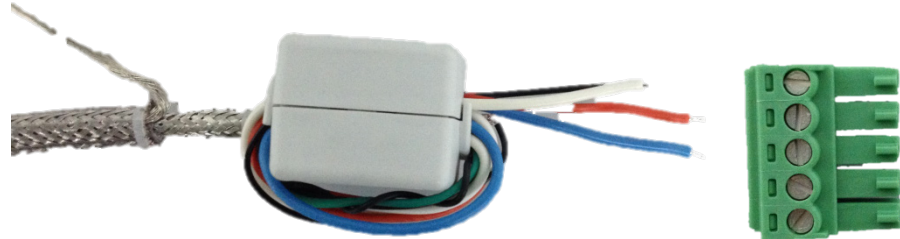

Figure 3-12 Ferrite Installed on POWERCELL® Cable



Figure 3-13 Load Cell Connector Pin Assignment

Table 3-2: Load Cell Connector Pin Assignment

Pin No	Signal Definition	Description	Wire Color of SWB605 Homerun Cable
1	CANH	CAN Bus High	White
2	----	Not Used	----
3	CANL	CAN Bus Low	Blue
4	VOUT	Power Supply	Red
5	GND	Power Ground	Black

Example: Connect ACT350POWERCELL® to SWB605 Weighing Module. The Homerun cable is shown in Figure 3-14. Refer to Table 3-2 for the wiring connection. Please be aware that the Black GND wire is twisted with the Silver Shield wire to a ring terminal. It is recommended to cut the ring terminal and connect the Black GND wire to ACT350POWERCELL® while connecting the Silver Shield wire to the ground point of the cabinet where ACT350POWERCELL® is installed.

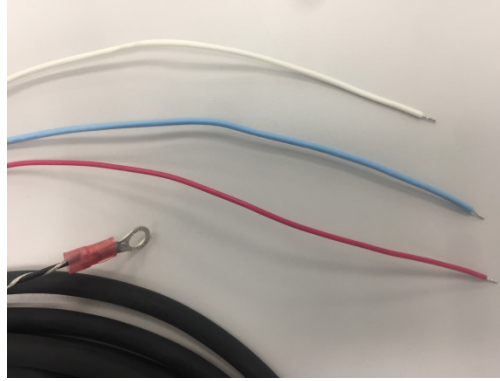

Figure 3-14: Scale Interface Connection

NOTICE

THE ACT350POWERCELL WILL NOT DISPLAY WEIGHT UNTIL THE LOAD CELLS ARE ADDRESSED. SEE THE "LOAD CELL CONFIGURATION" SUBSECTION OF THIS MANUAL FOR ADDITIONAL INFORMATION

3.2.4. PLC Connection

To connect an ACT350 with a PLC, use a PLC connection port shown on Figure 3-3. This document doesn't focus on programming on user's PLC. Device description files, sample codes, engineering notes and SAI (Standard Automation Interface) reference manual can be downloaded from www.mt.com/ind-act350-downloads. Use these to simplify your PLC programming while integrating ACT350.

For EMC protection, cabling for the PROFIBUS DP interface must include a ferrite, included with the transmitter.

Install the ferrite as indicated in Figure 3-15.



Figure 3-15: Ferrite Installed on PROFIBUS DP Cable

For the PROFINET IO and Ethernet/IP interfaces, the cables shall be industry standard 8P8C (also called RJ45) to allow the customer to quickly interface/connect modules.

ACT350POWERCELL[®] transmitter with PROFINET or EtherNet/IP interface supports Media Redundancy Protocol and Device Level Ring topology, respectively.

3.2.4.1. Media Redundancy Protocol (MRP) Topology

MRP protocol enables implementing redundant PROFINET communication through a ring topology without the need for switches. MRP can compensate for an individual failure in a PROFINET / Industrial Ethernet network in a simple ring topology. As meshed networks are not supported, MRP is both simple and reliable. MRP in PROFINET networks can achieve reconfiguration times of 200ms.

3.2.4.2. Device Level Ring (DLR) Topology

DLR protocol provides high network availability in a ring topology and is intended primarily for implementation in EtherNet/IP end-devices that have two Ethernet ports and embedded switch technology. It provides fast network fault detection and reconfiguration in order to support the most demanding control applications. For example, a ring network of 50 nodes implementing the DLR protocol has the worst case fault recovery time of less than 3ms.

3.3. DIP Switches

Two DIP switches, 1 and 2, are accessible from the underside of the ACT350POWERCELL's housing. Table 3-3 summarizes the functions of the DIP switches.

Table 3-3: DIP Switch Functions

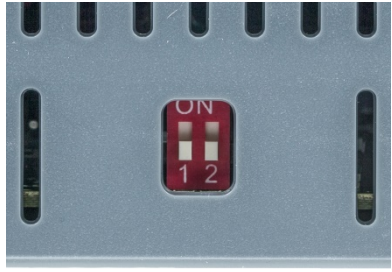
ACT350POWERCELL® DIP Switches	Legal for Trade	Reset	Function
	Switch 1	Switch 2	
	OFF	OFF	Normal operation
	ON	OFF	Legal-for-trade mode; calibration data protected
	OFF	ON	Master reset of all data during transmitter power-up
	ON	ON	Reset of all except calibration data during transmitter power-up

3.4. Legal for Trade

When the transmitter is certified as legal for trade, DIP switch 1, accessible on the underside of the housing, must be set to ON. A metrological seal must be placed over the DIP switch array to prevent this setting from being changed.

Please refer to Figure 3-16 for the method to seal the ACT350POWERCELL® Transmitter.

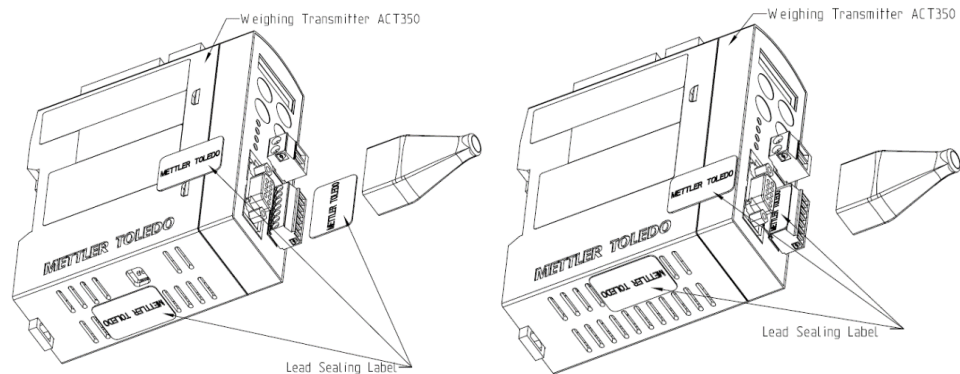

Figure 3-16 ACT350POWERCELL® Sealing Diagram

NOTICE

WHEN THE TRANSMITTER IS IN LEGAL FOR TRADE MODE, METROLOGICALLY SIGNIFICANT SETTINGS CANNOT BE ACCESSED VIA KEYPAD, WEBSERVER OR IN SETUP+. THESE INCLUDE UNIT, CAPACITY, INCREMENT SIZE, CALIBRATION, ZERO AND STABILITY SETTINGS.

3.5. Power Supply

The ACT350POWERCELL® transmitter is powered only by external DC input (24V). The ACT350xx POWERCELL must only be powered by external 12 VDC. See Hazardous Area Installation Guide for ACT350xx / ACT350xx POWERCELL for more information.

4 Fieldbus Communication

4.1. Overview

The Standard Automation Interface (SAI) is a protocol designed to exchange data between METTLER TOLEDO devices and third-party automation systems. This interface provides the following:

- A common data layout for load cells, terminals and other devices regardless of the physical interface or automation network used.
- A single protocol for the convenience of automation integrators, control system programmers and our automation customers.
- A flexible protocol for diverse devices.

4.1.1. Communication Modes

The protocol has two primary modes of operation.

- cyclic data
- acyclic data

NOTICE

ACYCLIC DATA IS ALSO REFERRED TO AS ASYNCHRONOUS DATA OR EXPLICIT MESSAGING.

4.1.2. Cyclic Data

Cyclic data is broken up into sections of data. Each section represents a block. Each block of data contains four words of 16 bits each.

The data within these words can express numeric values, individual bits which represent state or command depending on the type of block specified.

Two fixed formats divided into blocks (1 block, 2 blocks) are available for the ACT350. The default format is the two block format with eight words in and eight words out. The number of input words (data sent from the ACT350 to the process controller) and output words (data sent from the process controller to the ACT350) always match.

Two types of cyclic blocks are supported on the ACT350:

- Measuring block (IEEE 754 floating point data)
 - Used for numeric values
 - Decimal point and sign included and do not require special data handling

- Status block
 - Used for numeric values
 - Status block data grouped together in 16 bit words.

4.1.3. Acyclic Data

With acyclic messages, the variable can be accessed directly through a unique name or number defined by the control system's acyclic message block.

<i>NOTICE</i>
ACYCLIC DATA IS ALSO REFERRED TO AS ASYNCHRONOUS DATA OR EXPLICIT MESSAGING.
<i>NOTICE</i>
FOR MORE DETAILS REGARDING FIELDBUS COMMUNICATION PLEASE REFER TO ACT-WEIGHT TRANSMITTERS SAI REFERENCE MANUAL AVAILABLE AT WWW.MT.COM/IND-ACT350-DOWNLOADS.

5 Troubleshooting PLC Connectivity

If the ACT350POWERCELL[®] does not communicate with the PLC, do the following:

- Power cycle the ACT350POWERCELL[®] to reestablish communications.
- A solid green NW LED on the front panel implies that the ACT350POWERCELL[®] is on the network and cyclic communication to the PLC is established. A flashing NW LED indicates that the ACT350POWERCELL[®] is not on the fieldbus network or cyclic communication to the PLC is not established.
- Check LED status of the connection socket. The top LED should be solid green. If the top LED is not solid green, this implies that no hardware connection is seen by the device -check cabling and connector insertions. The bottom LED will blink amber if data is being transferred. If the top LED is solid green, but the bottom LED is not blinking, this implies a configuration issue - either in the ACT350POWERCELL[®] or the PLC.
- Confirm that the ACT350POWERCELL[®] can respond to a ping on the network. If it doesn't, check the port settings, wiring and network connections.
- Diagnose and correct specific network error conditions such as IP Address conflicts.
- Confirm that the ACT350POWERCELL[®] settings for address, format and byte order match those in the PLC and that each ACT350POWERCELL[®] has a unique address.
- Check the Electronic Keying from in the PLC program. Confirm that the firmware revision of the Ethernet/IP module in the ACT350POWERCELL[®] is greater than or equal to the firmware revision specified in the ACT350 POWERCELL's communication module in the PLC. Change the firmware revision being looked for in the PLC's communication module if necessary.
- Visit the METTLER TOLEDO web page at [www.mt.com/ind-ACT350 POWERCELL-downloads](http://www.mt.com/ind-ACT350_POWERCELL-downloads) to check for other Troubleshooting information.
- Contact METTLER TOLEDO for additional troubleshooting help.

6 Configuration and Maintenance Tools

Two tools can be used for configuration and maintenance of ACT350/ACT350xxPOWERCELL[®]: Webserver and Setup+[™].

6.1. ACT350/ACT350xxPOWERCELL[®] Webserver

The ACT350/ACT350xxPOWERCELL[®] webserver is a built-in tool and supports the following functions:

- Configuration of the ACT350/ACT350xxPOWERCELL[®] Transmitter via web browser, such as IE, Chrome and Safari;
- Access diagnostic and maintenance information for service purposes;

NOTICE

THE WEBSERVER IS AVAILABLE ONLY FOR PROFINET AND EtherNet/IP TYPES: THE PROFIBUS DP VERSION DOES NOT SUPPORT WEBSERVER

6.1.1. PC and ACT350/ACT350xxPOWERCELL[®] Setup

NOTICE

THE WEBSERVER IS AVAILABLE FOR UNITS WITH SERIAL NUMBER STARTING FROM B750152347. MAKE SURE THE PC AND ACT350/ACT350xxPOWERCELL[®] TRANSMITTER ARE IN THE SAME LOCAL NETWORK.

In order to use the webserver on ACT350/ACT350xxPOWERCELL[®], your PC and ACT350/ACT350xxPOWERCELL[®] transmitter must be in the same local network. They need to be physically connected on the same network, and have correct IP configurations. The IP configuration of the ACT350/ACT350xxPOWERCELL[®] transmitters can be done using the front panel keys. Based on the operation system, the way to set IP configuration of the PC can be different. A PC on Windows 10 for example:

Go to Control Panel\Network and Internet\Network Connections --> select the Ethernet device --> double click "Internet Protocol Version 4 (TCP/IP)"

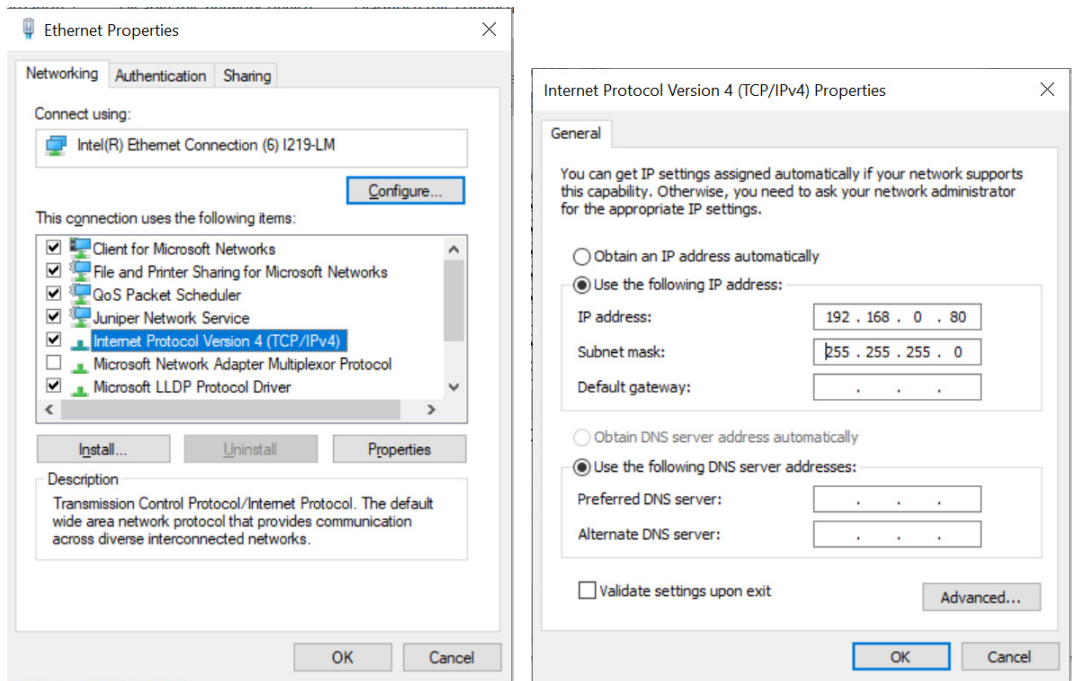

Figure 6-1 Local Area Connection Setting

Typical PC and ACT350/ACT350xxPOWERCELL® IP configuration:

PC: IP address: 192.168.0.X (X = 0 ~ 255, avoid use 2 if possible, since the default IP address of ACT350/ACT350xxPOWERCELL® is 192.168.0.2), Subnet Mask: 255.255.255.0

ACT350/ACT350xxPOWERCELL®: IP address: 192.168.0.Y (Y = 0 ~ 255), Subnet Mask: 255.255.255.0

If there are more than one ACT350/ACT350xxPOWERCELL® on the network, each of them shall have individual "Y".

6.1.2. IE Setup

Internet Options -> Connections -> LAN settings -> Automatically detect settings should be unchecked.

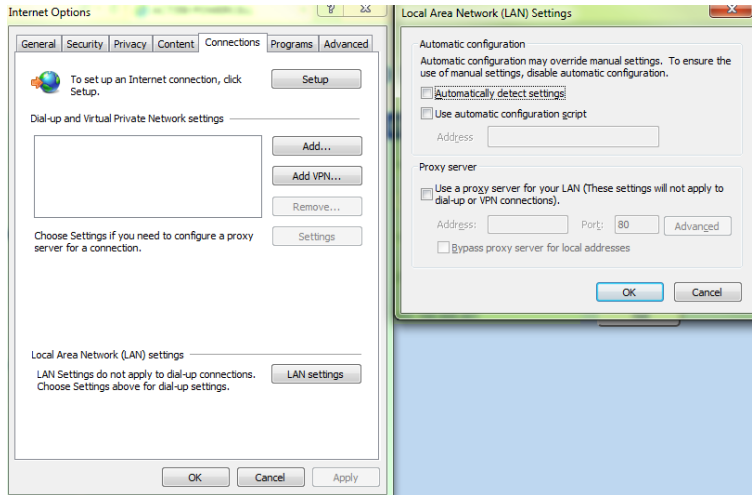

Figure 6-2: IE Setting

By entering the IP address of the ACT350/ACT350xxPOWERCELL[®] Transmitter in the web browser, the startup screen of the webserver will be displayed.

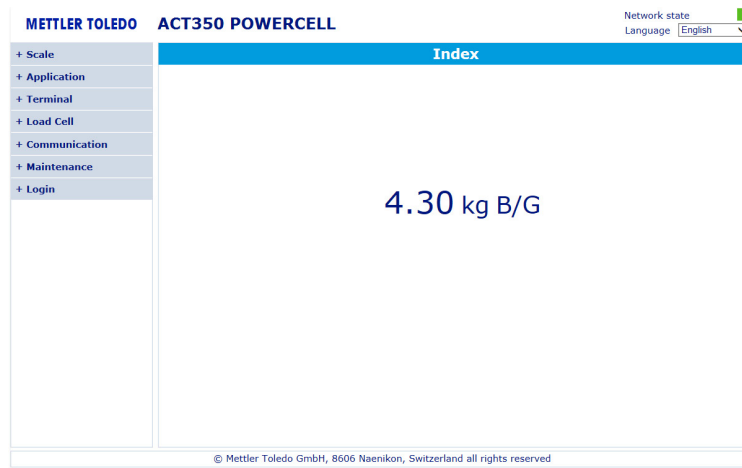

Figure 6-3 Webserver Splash Screen

The Webserver only works when the PC is connected to the ACT350/ACT350xxPOWERCELL[®] Transmitter. The connection status can be checked in the top right corner "Network state".



Figure 6-4 Webserver Connecting status (Online/Offline)

6.1.3. Webserver Menu Structure

Webserver can be used to configure, maintain or troubleshoot ACT350/ACT350xxPOWERCELL® transmitters. The functions can be selected from the menu on the left side of the webserver interface. The structure of the menu is featured in the chart below:

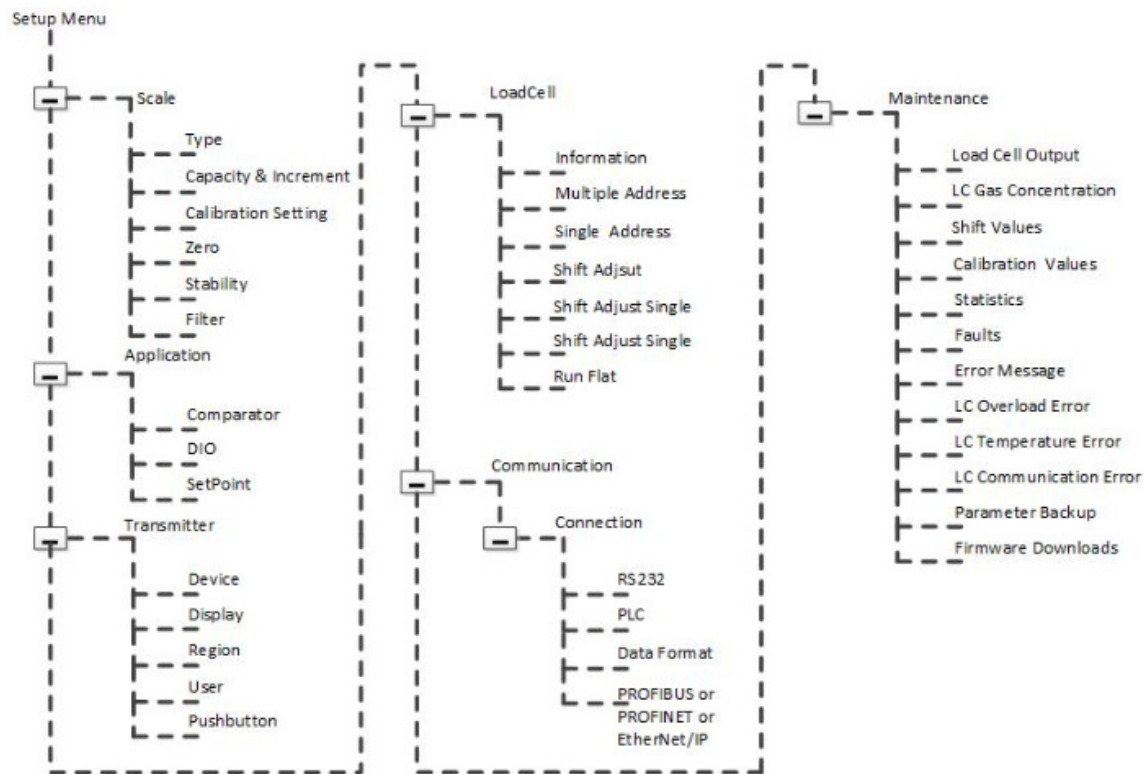

Figure 6-5 Webserver Menu Structure

6.2. Setup+ Configuration Tool

PROFIBUS DP version of the ACT350/ACT350xxPOWERCELL® transmitter does not support webserver since there is no Ethernet port on the device. Setup+™ software can be used instead.

6.2.1. General Overview



Figure 6-6: Setup+ Splash Screen

Setup+ is a PC tool available online to support the following functions:

- Configuration of the ACT350/ACT350xxPOWERCELL® Transmitter using local PC

- Save transmitter configuration to a local PC
- Load a saved configuration to other transmitters performing similar applications
- Restore to a 'last known good state' for service purposes
- ACT350/ACT350xxPOWERCELL® Transmitter software upgrade and maintenance

6.2.2. PC Installation

Please download the Setup+ installation guide and the Setup+ software from www.mt.com/ind-act350-downloads.

6.2.3. Setup+ User Guide

Open Setup+ on your PC and click on the **Help** icon in the toolbar to download the **Setup+ User's Guide**.

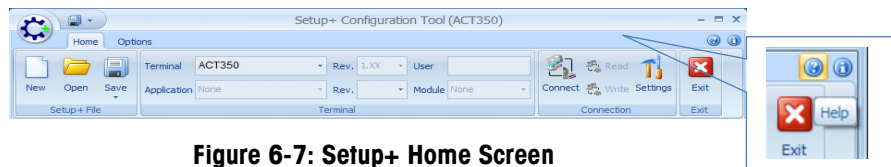

Figure 6-7: Setup+ Home Screen

7 GEO Codes

The GEO code feature provided in the ACT350 transmitter permits calibration readjustment due to changes in elevation or latitude without reapplying test weights. This adjustment assumes a previously accurate calibration was done with the GEO code set properly for that original location and that the GEO code for the new location can be accurately determined. The procedure for using this feature is as follows.

7.1. Original Site Calibration

1. Use the GEO code chart (Table 7-1) on the following pages to determine the GEO code for the current altitude and location at which the scale will be calibrated.
2. Enter that GEO value into the GEO code parameter in setup at **Scale > Calibration**.
3. Immediately after entering the GEO code, perform a zero and span adjustment using accurate test weights.
4. Exit the setup menu tree.
5. The scale can now be used in its new location.

7.2. New Site GEO Code Adjustment

When a terminal is to be reinstalled at a different geographic location, gravitational and altitude changes can be accounted for by following these steps. Note that this procedure is not necessary if an on-site recalibration is performed.

1. Use the GEO code chart (Table 7-1) on the following pages to determine the GEO code for the new altitude and location at which the scale will be used.
2. Enter that GEO value into the GEO code parameter in Setup at **Scale > Calibration**.
3. Immediately after entering the GEO code, exit the setup menu tree. DO NOT perform a normal calibration.

The calibration has now been adjusted for the differences in gravity from the original site of calibration to the new site of use.

- Using the GEO code value for calibration adjustment is not as accurate as re-applying certified test weights and re-calibrating the scale in a new location.

Table 7-1: GEO Adjustment Values

Latitude North or South, in Degrees and Minutes	Height Above Sea Level, in Meters										
	0	325	650	975	1300	1625	1950	2275	2600	2925	3250
	325	650	975	1300	1625	1950	2275	2600	2925	3250	3575
	Height Above Sea Level, in Feet										
	0	1060	2130	3200	4260	5330	6400	7460	8530	9600	10660
1060	2130	3200	4260	5330	6400	7460	8530	9600	10660	11730	
0° 0'–5° 46'	5	4	4	3	3	2	2	1	1	0	0
5° 46'–9° 52'	5	5	4	4	3	3	2	2	1	1	0
9° 52'–12° 44'	6	5	5	4	4	3	3	2	2	1	1
12° 44'–15° 6'	6	6	5	5	4	4	3	3	2	2	1
15° 6'–17° 0'	7	6	6	5	5	4	4	3	3	2	2
17° 10'–19° 2'	7	7	6	6	5	5	4	4	3	3	2
19° 2'–20° 45'	8	7	7	6	6	5	5	4	4	3	3
20° 45'–22° 22'	8	8	7	7	6	6	5	5	4	4	3
22° 22'–23° 54'	9	8	8	7	7	6	6	5	5	4	4
23° 54'–25° 21'	9	9	8	8	7	7	6	6	5	5	4
25° 21'–26° 45'	10	9	9	8	8	7	7	6	6	5	5
26° 45'–28° 6'	10	10	9	9	8	8	7	7	6	6	5
28° 6'–29° 25'	11	10	10	9	9	8	8	7	7	6	6
29° 25'–30° 41'	11	11	10	10	9	9	8	8	7	7	6
30° 41'–31° 56'	12	11	11	10	10	9	9	8	8	7	7
31° 56'–33° 9'	12	12	11	11	10	10	9	9	8	8	7
33° 9'–34° 21'	13	12	12	11	11	10	10	9	9	8	8
34° 21'–35° 31'	13	13	12	12	11	11	10	10	9	9	8
35° 31'–36° 41'	14	13	13	12	12	11	11	10	10	9	9
36° 41'–37° 50'	14	14	13	13	12	12	11	11	10	10	9
37° 50'–38° 58'	15	14	14	13	13	12	12	11	11	10	10
38° 58'–40° 5'	15	15	14	14	13	13	12	12	11	11	10
40° 5'–41° 12'	16	15	15	14	14	13	13	12	12	11	11
41° 12'–42° 19'	16	16	15	15	14	14	13	13	12	12	11
42° 19'–43° 26'	17	16	16	15	15	14	14	13	13	12	12
43° 26'–44° 32'	17	17	16	16	15	15	14	14	13	13	12
44° 32'–45° 38'	18	17	17	16	16	15	15	14	14	13	13

Latitude North or South, in Degrees and Minutes	Height Above Sea Level, in Meters										
	0	325	650	975	1300	1625	1950	2275	2600	2925	3250
	325	650	975	1300	1625	1950	2275	2600	2925	3250	3575
	Height Above Sea Level, in Feet										
	0	1060	2130	3200	4260	5330	6400	7460	8530	9600	10660
1060	2130	3200	4260	5330	6400	7460	8530	9600	10660	11730	
45° 38'–46° 45'	18	18	17	17	16	16	15	15	14	14	13
46° 45'–47° 51'	19	18	18	17	17	16	16	15	15	14	14
47° 51'–48° 58'	19	19	18	18	17	17	16	16	15	15	14
48° 58'–50° 6'	20	19	19	18	18	17	17	16	16	15	15
50° 6'–51° 13'	20	20	19	19	18	18	17	17	16	16	15
51° 13'–52° 22'	21	20	20	19	19	18	18	17	17	16	16
52° 22'–53° 31'	21	21	20	20	19	19	18	18	17	17	16
53° 31'–54° 41'	22	21	21	20	20	19	19	18	18	17	17
54° 41'–55° 52'	22	22	21	21	20	20	19	19	18	18	17
55° 52'–57° 4'	23	22	22	21	21	20	20	19	19	18	18
57° 4'–58° 17'	23	23	22	22	21	21	20	20	19	19	18
58° 17'–59° 32'	24	23	23	22	22	21	21	20	20	19	19
59° 32'–60° 49'	24	24	23	23	22	22	21	21	20	20	19
60° 49'–62° 9'	25	24	24	23	23	22	22	21	21	20	20
62° 9'–63° 30'	25	25	24	24	23	23	22	22	21	21	20
63° 30'–64° 55'	26	25	25	24	24	23	23	22	22	21	21
64° 55'–66° 24'	26	26	25	25	24	24	23	23	22	22	21
66° 24'–67° 57'	27	26	26	25	25	24	24	23	23	22	22
67° 57'–69° 35'	27	27	26	26	25	25	24	24	23	23	22
69° 5'–71° 21'	28	27	27	26	26	25	25	24	24	23	23
71° 21'–73° 16'	28	28	27	27	26	26	25	25	24	24	23
73° 16'–75° 24'	29	28	28	27	27	26	26	25	25	24	24
75° 24'–77° 52'	29	29	28	28	27	27	26	26	25	25	24
77° 52'–80° 56'	30	29	29	28	28	27	27	26	26	25	25
80° 56'–85° 45'	30	30	29	29	28	28	27	27	26	26	25
85° 45'–90° 00'	31	30	30	29	29	28	28	27	27	26	26

A TCP/IP Communication

TCP/IP communication is a new feature supported by PROFINET or EtherNet/IP versions of the ACT350POWERCELL®. The user can connect their PC to ACT350POWERCELL® via the socket connection and perform the operations below using the MT-SICS protocol.

- Request the weighing results such as Gross/Tare/Net weight values,
- Remote Zero/Tare/Clear operations,
- Read the Serial Number and FW Revision Number.

A.1. Socket Connection

ACT350POWERCELL® opens port No. 81 for connection. Connect to ACT350POWERCELL® via the IP address and port No. 81. Only one socket connection is allowed. Make sure to close the Webserver of the ACT350POWERCELL® before attempting TCP/IP communication since the Webserver uses a socket connection.

A.2. Introduction to MT-SICS Commands

MT-SICS (METTLER TOLEDO Standard Interface Command Set) is a standardized command set from METTLER TOLEDO. Only the MT-SICS commands listed in Table A- 1 are supported by ACT350POWERCELL®.

Table A- 1: ACT350POWERCELL® MT-SICS Command List

No	Command	Description
1	SIX1	Provide complete weight information to host software, several status flags beside gross, net and tare value
2	TA	Request tare value
3	SI	Request net value
4	Z	Zero the scale.
5	ZI	Zero Immediately
6	T	Tare a stable weight value
7	TI	Tare Immediately
8	TAC	Clear tare value
9	I3	Inquiry of FW Revision Number

No	Command	Description
10	I4	Inquiry of Serial Number

A.2.1. Command Formats of MT-SICS

Each command received by ACT350POWERCELL® is acknowledged by a response to the host. Commands and responses are data strings with a fixed format. Commands sent to the ACT350POWERCELL® comprise one or more characters of the ASCII character set. Enter commands only in uppercase.

The parameters of the command must be separated from one another and from the command name by a space (ASCII 32 dec., in the examples shown in this section, a space is represented as _).

Each command must be terminated by CR LF (ASCII 13 dec., 10 dec.).

The characters CR and LF, which can be inputted using the **ENTER** or **RETURN** key of most entry keypads, are not listed in this description. However, it is essential they be included for communication with ACT350POWERCELL®.

A.2.1.1. SICS Command Example

Command to tare the ACT350POWERCELL®:

"TA" (The command terminator CR LF is not shown.)

A.2.2. Response Formats

All responses sent by ACT350POWERCELL® to acknowledge the received commands have one of the following formats:

- Response with weight value
- Response without weight value
- Error message

A.2.2.1. Format of the Response with Weight Value

A general description of the response with weight value as follows:

ID __ Status __ Weight Value __ Unit CR LF

Table A- 2: Response Format

No	Response Characters	Description
1	ID	Response identification
2	_	Space (ASCII 32 dec.)

No	Response Characters	Description
3	Status	Status of the ACT350POWERCELL®. Refer to the description of the commands and responses in the sections below
4	Weight Value	Weighing result, shown as a number with 10 digits, including sign directly in front of the first digit. The weight value appears right justified. Preceding zeroes are upressed with the exception of the zero to the left of the decimal point.
5	Unit	Weight unit displayed
6	CR	Carriage Return (ASCII 13 dec.)
7	LF	Line Feed (ASCII 10 dec.)

.2.2.1.1. Example

Response with a stable weight value of 0.256 kg:

S _ S _ _ _ _ _ 0.256 _ kg

Here CR LF is not shown.

A.2.2.2. Format of the Response without Weight Value

A general description of the response without weight value is as follows:

ID __ Status __ Paramters CR LF

Table A- 3: Response Format

No	Response Characters	Description
1	ID	Response identification
2	_	Space (ASCII 32 dec.)
3	Status	Status of the ACT350POWERCELL®. Refer to the description of the commands and responses in the sections below
4	Parameters	Command-dependent response code
5	CR	Carriage Return (ASCII 13 dec.)
6	LF	Line Feed (ASCII 10 dec.)

A.2.2.3. Error Messages

ID CR LF

Table A- 4: Response Format

No	Response Characters	Description
1	ID	Response identification, could be ES – Syntax error: ACT350POWERCELL® has not recognized the received command. ET – Transmission error: The scale has received a “faulty” command, such as a parity error. EL – Logical error: The command is understood, the parameter is incorrect. EI – Internal Error: The command is understood but cannot be executed at this time.
2	CR	Carriage Return (ASCII 13 dec.)
3	LF	Line Feed (ASCII 10 dec.)

A.3. SIX1 Command

A.3.1. Description

SIX1 is intended to provide complete weighing information for a variety of applications. To provide complete weight information to the terminal or host software, several status flags are provided along with the gross, net and tare values.

A.3.2. Syntax

Reads the parameters from ACT350POWERCELL®.

Command: SIX1

Response: SIX1 Sts MinW CoZ Rep Calc PosE StepE MarkE Range TM G N T Unit

A.3.3. Parameters

Table A- 5: SIX1 Command Response

No	Response Characters	Description
1	Sts	Status of the weighing, linked to the net value {Data type: character; encoding ASCII; range of characters see below} The statuses can have the following states: S Stable weight D Dynamic weight (unstable, not accurate) + Overload - Underload / Inclination I Invalid value
2	MinW	Always 0

No	Response Characters	Description
3	CoZ	Center of zero status [Data type: character; encoding ASCII; range of characters see below.] The center of zero status can have the following states: Z +/- ¼ d around gross zero. N Outside the limits of +/- ¼ d around gross zero
4	Rep	Repeating indicator [Data type: character; encoding ASCII; range of characters see below.] This field indicates, if the value has already been sent or if this is a new weight update (new computed weight value). Valid values are: R Repeated value (was already sent once or more) N New weight update (new computed weight value)
5	Calc	Always R
6	PosE	Always 0
7	StepE	Always 0
8	MarkE	Always 0
9	Range	Always 1
10	TM	Tare mode (no tare, manual tare, measured tare). [Data type: character; encoding ASCII; range of characters see below] Tare modes are: N no tare M measured tare P preset tare
11	G	Gross weight value
12	N	Net weight value
13	T	Tare weight value
14	Unit	The displayed unit

A.3.4. Example

Command: SIX1

Response: SIX1 S 0 Z N R 0 0 0 1 N 0.00 0.00 0.00 kg

A.4. TA Command

A.4.1. Description

TA command is used to request the tare weight value

A.4.2. Syntax

Command: TA

Response:

TA_A _ TareWeightValue _ Unit to report current Tare weight value.

TA_I – The command is understood but cannot be executed at this time

TA_L – Command understood, parameter wrong.

A.4.3. Example

Command: TA

Response: TA_A _ _ _ _ 10.00 _ kg

A.5. SI Command

A.5.1. Description

SI command is used to request the net weight value.

A.5.2. Syntax

Command: SI

Response:

S_A – Tare value cleared.

S_S _ WeightValue _ Unit – Stable weight value.

S_D _ WeightValue _ Unit – Non-stable weight value.

S_I – The command is understood but cannot be executed at this time.

S_+ – ACT350POWERCELL® in overload range.

S_- – ACT350POWERCELL® in underload range.

A.5.3. Example

Command: SI

Response: S_D _ _ _ _ 129.07 _ kg

A.6. Z Command

A.6.1. Description

Z command is used to zero the scale if the weight is stable.

A.6.2. Syntax

Command: Z

Response:

Z _ A – Zero setting performed.

Z _ I – The command is understood but cannot be executed at this time

Z _ + – Upper limit of zero setting range exceeded.

Z _ - – Lower limit of zero setting range exceeded.

A.6.3. Example

Command: Z

Response: Z _ A

A.7. ZI Command

A.7.1. Description

ZI command is used to zero the scale immediately.

A.7.2. Syntax

Command: ZI

Response:

ZI _ A – Zero the scale successfully

ZI _ I – The command is understood but cannot be executed at this time

ZI _ + – Upper limit of tare range exceeded.

ZI _ - – Lower limit of tare range exceeded.

A.7.3. Example

Command: ZI

Response: ZI _ A

A.8. T Command

A.8.1. Description

T command is used to tare a stable weight value.

A.8.2. Syntax

Command: T

Response:

T_S_WeightValue_Unit – Tare performed. Stability criterion and tare range comply with settings.

Current Tare weight value in current units is returned.

T_ I – Tare not performed

T_+ – Upper limit of tare range exceeded.

T_- – Lower limit of tare range exceeded.

A.8.3. Example

Command: T

Response: T _ S _ _ _ _ _ 100.00_kg

A.9. TI Command**A.9.1. Description**

TI command is used to tare immediately, even if the weight is unstable.

A.9.2. Syntax

Command: TI

Response:

TI _ S _ Weight Value _ Unit – Tare performed, stable tare value.

TI _ D _ Weight Value _ Unit – Tare performed, non-stable tare value.

TI _ I – The command is understood but cannot be executed at this time.

TI _ L – The command is understood, the parameter is wrong.

TI _ + – Upper limit of tare range exceeded.

TI _ - – Lower limit of tare range exceeded.

A.9.3. Example

Command: TI

Response: TI _ D _ _ _ _ _ 117.57 _ kg

A.10. TAC Command**A.10.1. Description**

TAC command is used to clear tare value.

A.10.2. Syntax

Command: TAC

Response:

TAC _ A – Tare value cleared.

TAC _ I – The command is understood but cannot be executed at this time

A.10.3. Example

Command: TAC

Response: TAC _ A

A.11. I3 Command

A.11.1. Description

I3 command is used to request the Firmware Revision Number.

A.11.2. Syntax

Command: I3

Response:

I3 _ A _ 1.00

A.12. I4 Command

A.12.1. Description

I4 command is used to request the ACT350POWERCELL® Serial Number.

A.12.2. Syntax

Command: I4

Response:

I4 _ B123456789

B Setpoint

B.1. Introduction

SetPoint is a simple application that allows for the digital inputs and outputs of the ACT350POWERCELL[®] to react to reaching pre-set weights determined by Target Weight, Pre-act and Fine Feed in the below equations.

$$CP1 = \text{Target Weight} - \text{Pre-act} - \text{Fine Feed}$$

$$CP2 = \text{Target Weight} - \text{Pre-act}$$

Fine Feed could be zero. In this case, SetPoint works in single speed mode. The Fast Output is disabled, only Fine Output works.

The Source is used to determine which value, Displayed Weight or Gross Weight, is compared to CP1 and CP2. The comparison result and Latch option determine the status of Fast Output and Fine Output. The Mode parameter determines how Fast Output and Fine Output work.

Table B- 1: SetPoint Settings

Mode	Options are either Concurrent or Independent
Source	Select whether the Gross Weight or Displayed Weight will be used as the source value to be compared to the target weight
Latch	Set to be either enabled or disabled. If enabled, SetPoint output is latched once the weight reaches CP2. The latch is cleared by starting the SetPoint application.
Target Weight	Set the target weight.
Pre-act	Weight of material expected to be added after the Fine Feed output goes FALSE.
Fine Feed	This parameter is used together with Target Weight and Pre-act to define the CP1.

B.2. Concurrent Mode

When Source is set to Gross Weight, two Outputs of Discrete IO are set respectively as Fast Output and Fine Output and gross weight is below CP1, both Fast and Fine Outputs are TRUE. The controlled valves in the user's equipment are open so the material filling speed is the fastest. Then when gross weight increases to hit CP1, Fast Output switches to FALSE and Fine Output remains TRUE until CP2 is reached. Both Fast and Fine Outputs are FALSE at this point and the corresponding valves are closed. The material filling is stopped. The whole process is shown in Figure B- 1.

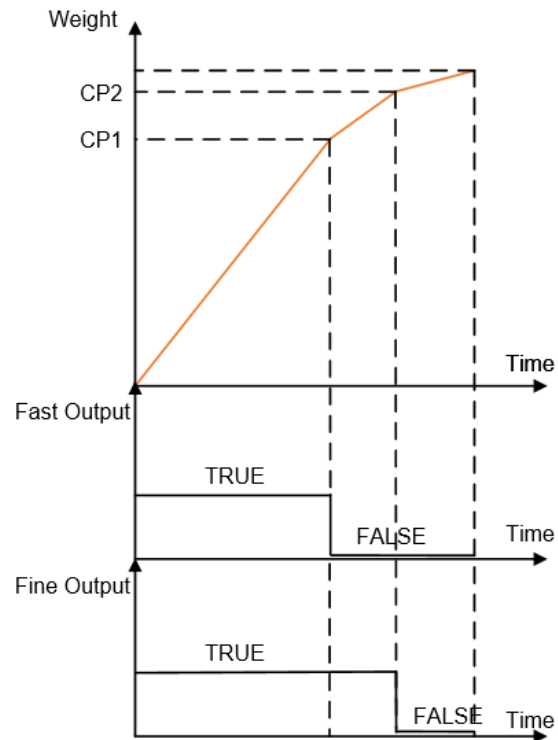

Figure B- 1: Concurrent Mode

B.3. Independent Mode

In this mode the Fast Output and Fine Output will be TRUE sequentially. Figure B- 2 shows the difference to Concurrent Mode.

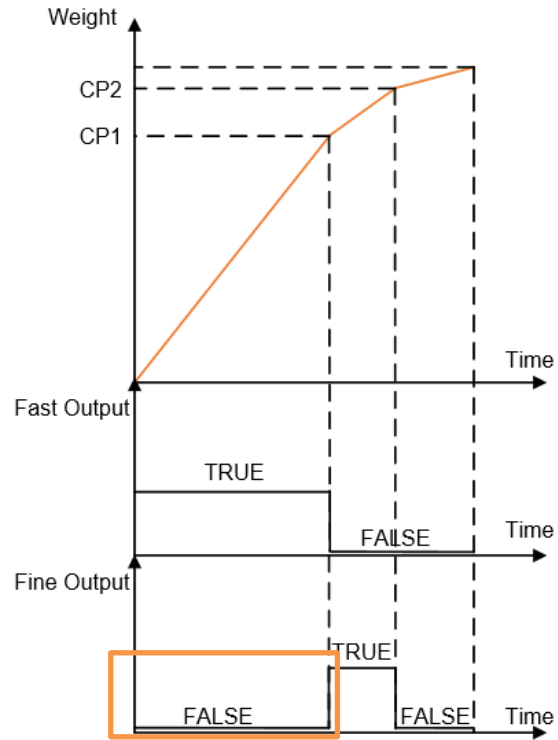

Figure B- 2: Independent Mode

B.4. Latch

When Latch is enabled, once the weight is above CP2, the DIO Outputs are latched at FALSE regardless of further weight changes, e.g. weight decreases to be less than CP2 or even CP1. The FALSE status remains until a Start/Resume SetPoint signal is triggered via a Discrete IO input.

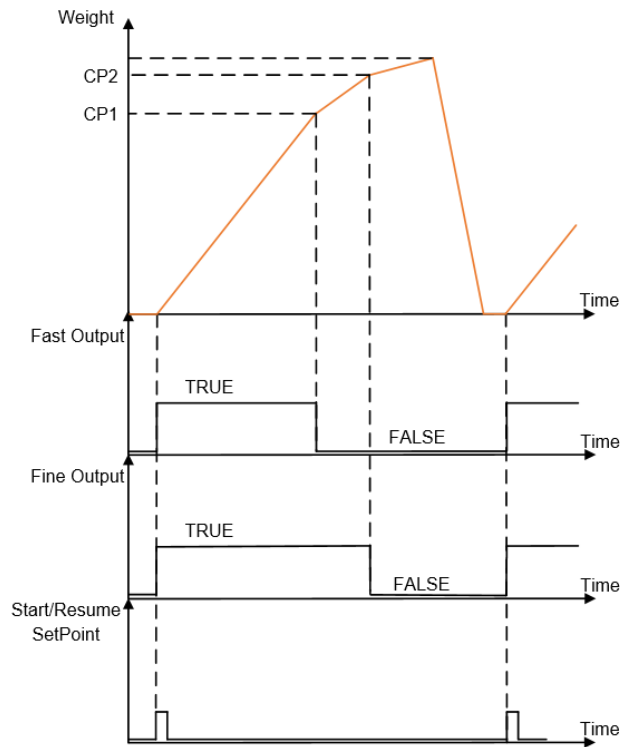

Figure B- 3: Latch Enabled with Start/Resume Input

The Abort SetPoint application input signal can be used to pause the SetPoint process. In this case, the Fast and Fine Outputs will change to FALSE regardless of the comparison result between weight and CP1/CP2. A Start/Resume SetPoint signal is required to resume the process.

When Latch is Disabled, Start/Resume SetPoint and Abort SetPoint application signal are ignored. The Fast and Fine Outputs are only determined by the comparison result between weight and CP1/CP2.

METTLER TOLEDO Service

To protect your METTLER TOLEDO product's future:

Congratulations on choosing the quality and precision of METTLER TOLEDO. Proper use according to these instructions and regular calibration and maintenance by our factory-trained service team ensure dependable and accurate operation, protecting your investment. Contact us about a METTLER TOLEDO service agreement tailored to your needs and budget.

We invite you to register your product at www.mt.com/productregistration so we can contact you about enhancements, updates and important notifications concerning your product.

www.mt.com

For more information

Mettler-Toledo, LLC

1900 Polaris Parkway
Columbus, OH 43240
Phone 800 438 4511
Fax 614 438 4900

© 2020Mettler-Toledo, LLC
30423600 Rev. 03, 04/2020



30423600